

LINEAR



MGNT 100 p.11



40.150 p.19



55.300 Linear / p.27



54.030 Linear / p.29



54.010 Linear / p.33

**RECESSED
TRIMLESS**

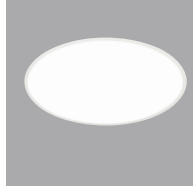

10.300 / p.36

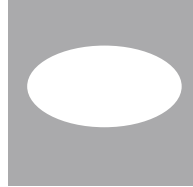

10.001 / p.37

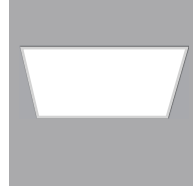

11.300 / p.38



15.010 / p.39

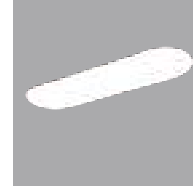

15.020 / p.41

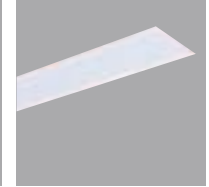

15.200 / p.42



15.105 / p.43



10.200 / p.44



10.201 / p.44



10.202 / p.45



SA15.045 / p.46



SA15.046 / p.47



SA 18.045 / p.48



TRM 18.045 / 48



SA 15.046 / p.51



TRM15.046 / p.51



TRM15.081 / p.52



TRM15.082 / p.52



SA 10.425 / p.53



SA 11.050 / p.55



SA 11.300 / p.55



SA 11.075 / p.56

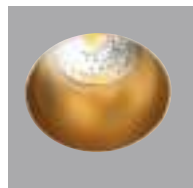

SA 15.060 / p.56

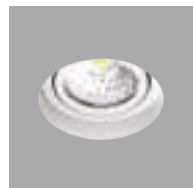

SA 15.040 / p.57



SA 10.430 / p.58



SA 12.040 / p.59



SA 12.030 / p.61



SA 12.031 / p.61



SA12.032 / p.61



SA 10.097 / p.62



SA 10.400 / p.62



SA 11.050 / p.63



SA10.054 / p.63



SA 14.043 / p.64



SA 12.044 / p.64



SA 11.078 / p.65

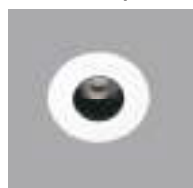

SA 15.300 / p.65



SA 10.410 / p.66



SA 10.415 / p.67



SA 10.425 / p.68



SA 10.330 / p.69

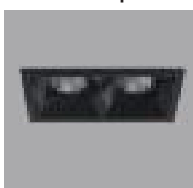

SA 10.332 / p.69

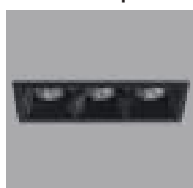

SA 10.333 / p.69



11.601 / p.70



11.602 / p.70



11.603 / p.70



11.604 / p.71

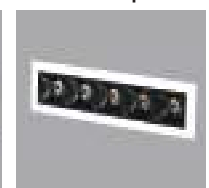

11.605 / p.71



11.609 / p.71



SA 11.081 / p.72



SA 11.082 / p.72



10.014.L / p.73



10.162 / p.74

SURFACE MOUNTED



40.160 / p.77



40.130 / p.79



40.140 / p.81



40.085 / p.83



40.040 / p.85



40.095 / p.87

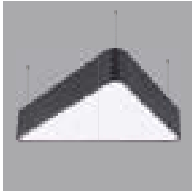

50.170 / p.88



40.070 / p.89



40.100 / p.90



40.110 / p.91



40.120 / p.92



50.055 / p.93

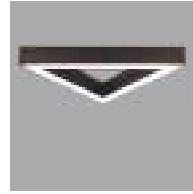

50.065 / p.94



40.063 / p.95



40.065 / p.96



40.066 / p.96



40.0667 / p.96



40.431 / p.97



40.432 / p.97



40.201 / p.99



40.202 / p.99



40.203 / p.99



40.036 / p.100



40.651 / p.101



40.650 / p.100



40.221 / p.102



40.222 / p.102



40.223 / p.102



40.010 / p.103



40.011 / p.103



40.012 / p.103



40.013 / p.103



10.162

PENDANT



50.050.57 / P.107



50.110 / P.108



50.004 / P.109



50.300 / P.111



50.301 / P.111



50.060 / P.112



50.200 / P.113



50.047 / P.114



50.048 / P.114



50.049 // P.115



60.300/60.30 / P.116



50.210 / P.117

WALL MOUNTED



54.015 / p.121



30.055 / p.122



30.065 / p.123



30.060 - 61 / p.124



30.022 / p.125



30.035 / p.126



30.061 / p.127

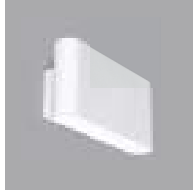

30.062 / p.127



30.055 / p.128



30.050 / p.129



30.051 / p.129



30.019 / p.130



30.020 / p.130

TRACK LIGHT



20.010 / p.132



20.020 / p.132



20.030 / p.133



20.040 / p.133

DECORATIVE OFFICE and HOTEL LUMINAIRES



60.001 / p.136



60.002 / p.137

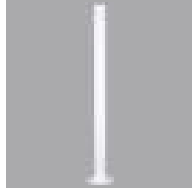

60.060 / p.138



60.061 / p.139

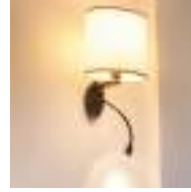

60.110 / p.140



60.111 / p.140



60.130 / p.141



60.120 / p.142

OUTDOOR LIGHTING



70.110 / p.144



70.370 / p.144



70.560 / p.145



70.060 / p.147



70.061 / p.147



70.063 / p.149



70.062 / p.149



70.013 / p.150



70.014 / p.150

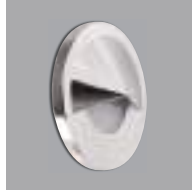

70.080 / p.152



70.082 / p.152



70.083 / p.152

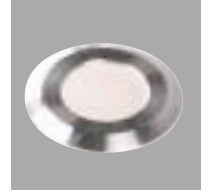

70.084 / p.153



70.090 / p.153

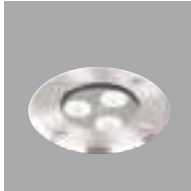

70.091 / p.153



70.2041 / p.154



70.2042 / p.154



70.2043 / p.154



70.1181 / p.155



70.1182 / p.155



70.1184 / p.155



90.120 / p.156



90.110 / p.156



70.520 / p.157



70.035 / p.158



70.036 / p.158



70.037 / p.159



70.501 / p.160



70.510 / p.162

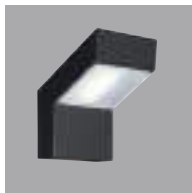

70.010 / p.163



70.004 / p.163



70.002 / p.164



70.053 / p.164



70.005 / p.165



70.040 / p.165



70.055 / p.166



70.051 / p.166



70.8025 / p.167



70.8015 / p.167



70.331 / p.169



70.330 / p.170



70.5360 / p.171



70.5365 / p.172



70.5375 / p.173



70.5380 / p.174



70.5381 / p.175













RECESSED
Siva Altı Trimless

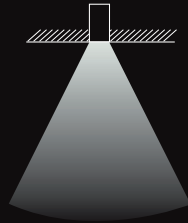

CEILING
Siva Üstü

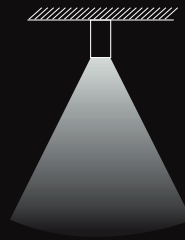

SUSPENDED
Sarkit

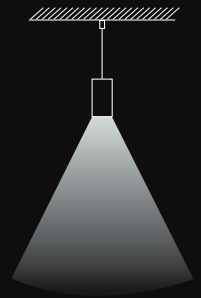

siva altı trimless

RECESSED

siva üstü

CEILING

Sarkit

SUSPENDED



sıva altı trimless sistemi Recessed trimless system

Mıknatıslı sistem sayesinde araç gereç kullanılmadan ürün yerleştirme ve çıkarma esnekliği verir.

Çerçevesiz kurulum ve aerodinamik noktalar özellikle zarif bir sistem oluşturur.

Mıknatıs sayesinde eklemiş olduğunuz ürünü istediğiniz şekilde sağa sola kaydırarak nesnelere istediğiniz gibi vurgulayabilirsiniz.

Tüm parçaları döndür, kaydır sistemi ile istediğiniz pozisyona getirin ve istediğiniz zaman ayarlayın.

Thanks to its magnetic system, it provides flexibility to place and remove products without using tools.

The frameless installation and aerodynamic points create a particularly elegant system.

Thanks to the magnet you can add the product to the left and right as you want to highlight the objects as you want.

Rotate all parts, move the slide to the desired position and adjust at any time.





CEILING
Siva Üstü



SUSPENDED
Sarkıt

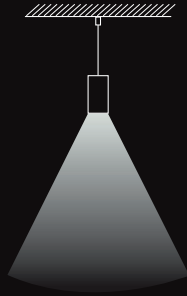

siva üstü & sarkıt sistemi ceiling & suspended system

Mıknatıslı sistem sayesinde araç gereç kullanılmadan ürün yerleştirme ve çıkarma esnekliği verir.

Çerçevesiz kurulum ve aerodinamik noktalar özellikle zarif bir sistem oluşturur.

Mıknatıs sayesinde eklemiş olduğunuz ürünü istediğiniz şekilde sağa sola kaydırarak nesnelere istediğiniz gibi vurgulayabilirsiniz.

Tüm parçaları döndür, kaydır sistemi ile istediğiniz pozisyona getirin ve istediğiniz zaman ayarlayın.

Thanks to its magnetic system, it provides flexibility to place and remove products without using tools.

The frameless installation and aerodynamic points create a particularly elegant system.

Thanks to the magnet you can add the product to the left and right as you want to highlight the objects as you want.

Rotate all parts, move the slide to the desired position and adjust at any time.



CODE : **MGNT 100**

Ral 9005

Ral 9006

Ral 9016

• Tüm RAL seçenekleri
• All colors available



IP20

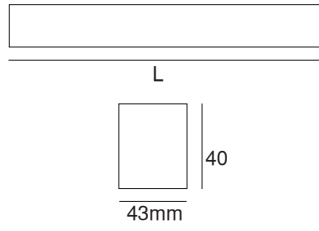

SYS. POWER	COLOR TEMP.	LUM.FLUX	L(mm)
14W	3000K	000 LM	610 mm
	4000K	000 LM	
28W	3000K	000 LM	910mm
	4000K	000 LM	

CODE : **MGNT 140**

Ral 9005

Ral 9006

Ral 9016

• Tüm RAL seçenekleri
• All colors available



IP20

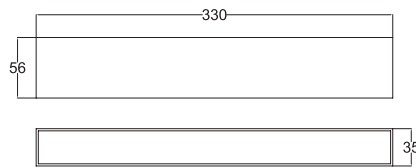

SYS. POWER	COLOR TEMP.	LUM.FLUX
10W	3000K	1200 lm
	4000K	1300 lm

CODE : **MGNT 120**

Ral 9005

Ral 9006

Ral 9016

• Tüm RAL seçenekleri
• All colors available



IP20

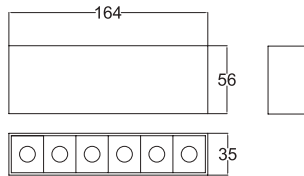

SYS. POWER	COLOR TEMP.	LUM.FLUX
12W	3000K	1400 lm
	4000K	1550 lm

CODE : **MGNT 130**

Ral 9005

Ral 9006

Ral 9016

• Tüm RAL seçenekleri
• All colors available



IP20

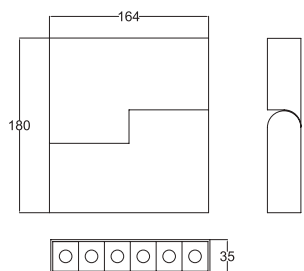

SYS. POWER	COLOR TEMP.	LUM.FLUX
12W	3000K	1400 lm
	4000K	1550 lm

CODE : **MGNT 110**

Ral 9005

Ral 9006

Ral 9016

• Tüm RAL seçenekleri
• All colors available



IP20

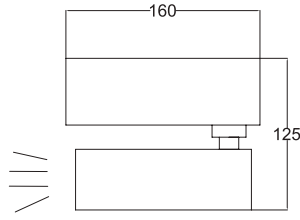

SYS. POWER	COLOR TEMP.	LUM.FLUX
10W	3000K	1200 lm
	4000K	1300 lm

CODE : **MGNT 150**

Ral 9005

Ral 9006

Ral 9016

• Tüm RAL seçenekleri
• All colors available



IP20

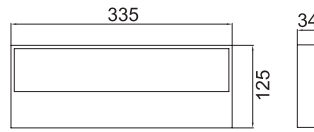

SYS. POWER	COLOR TEMP.	LUM.FLUX
19W	3000K	2200 lm
	4000K	2400 lm

CODE : **MGNT 160**

Ral 9005

Ral 9006

Ral 9016

• Tüm RAL seçenekleri
• All colors available



IP20

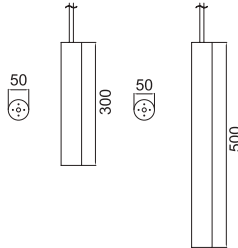

SYS. POWER	COLOR TEMP.	LUM.FLUX
9W	3000K	1100 lm
	4000K	1200 lm

CODE : **MGNT 161**

Ral 9005

Ral 9006

Ral 9016

• Tüm RAL seçenekleri
• All colors available



IP20

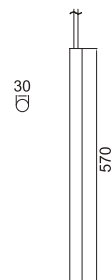

SYS. POWER	COLOR TEMP.	LUM.FLUX
2W	3000K	300 lm
	4000K	330 lm



CEILING
Sıva Üstü

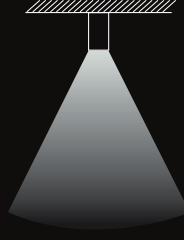

SUSPENDED
Sarkit

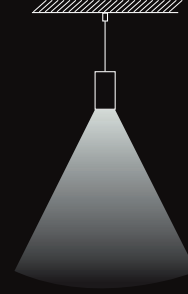

sıva üstü & sarkit sistemi ceiling & suspended system

Tüm uygulamalarda
kesintisiz hat projeleri için
ideal bir çözüm.

*The ideal solution
for continuous line projects in
all applications.*



CODE : **40.150**

Ral 9005

Ral 9006

Ral 9016

• Tüm RAL seçenekleri
• All colors available



IP20



CODE : **40.151**

Ral 9005

Ral 9006

Ral 9016

• Tüm RAL seçenekleri
• All colors available



IP20





CODE : **40.152**

Ral 9005

Ral 9006

Ral 9016

• Tüm RAL seçenekleri
• All colors available



IP20



CODE : **40.153**

Ral 9005

Ral 9006

Ral 9016

• Tüm RAL seçenekleri
• All colors available



IP20







LİNEAR PROFİL SİSTEMLERİ linear profile systems

LINEAR PROFİL SİSTEMLERİ linear profile systems







SIVA ALTI LİNEAR PROFİL recessed linear profile



Ekstrüzyon alüminyum profilden üretilmiş armatür gövdesi. 35mm, 70mm, 82.8mm ve 108mm genişliğinde sürekli aydınlatma sistemleri için tasarlanmış elektrostatik toz boyalı olarak ; beyaz, gri, koyu gri, siyah, bej renkleri dışında istenilen RAL renkleri uygulanabilir.

Düzgün aydınlatma için yüksek ışık geçirgenliği ile opal difüzör ile homojen bir ışık sistemine sahiptir. Çok iyi renk verimi ile enerji tasarruflu Led'ler; 2700K, 3000K,4000K ve 6500K renklerinde CRI = 80, Min. 50000 saat ömründe ledler kullanılmaktadır. İsteğe bağlı olarak Dim seçeneği kullanılabilir.



Armature body made of extruded aluminum profile. 35mm, 70mm, 82.8mm and 108mm wide electrostatic powder coated designed for continuous lighting systems; other RAL colors can be applied except white, gray, dark gray, black and beige colors.

It has a homogeneous light system with opal diffuser with high light transmittance for smooth lighting. Energy saving LEDs with very good color efficiency; 2700K, 3000K, 4000K and 6500K colors CRI = 80, Min. LEDs are used in the service life of 50000 hours. Optionally, the Dim option is available.





43mm RECESSED LINEAR

Ral 9005

Ral 9006

Ral 9016

• Tüm RAL seçenekleri / All colors available

CODE : **55.300** RECESSED LINEAR

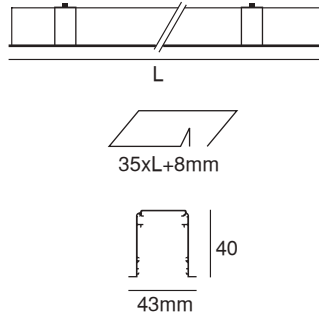

SYS. POWER	COLOR TEMP.	LUM.FLUX	L(mm)
18W	3000K	2200 LM	610 mm
	4000K	2400 LM	
27W	3000K	3300 LM	910mm
	4000K	3500 LM	
36W	3000K	4400 LM	1210mm
	4000K	4600 LM	
45W	3000K	5400 LM	1510 mm
	4000K	5600 LM	



70mm RECESSED LINEAR

Ral 9005

Ral 9006

Ral 9016

• Tüm RAL seçenekleri / All colors available

CODE : **55.001** RECESSED LINEAR

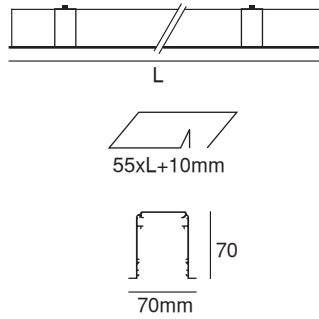

SYS. POWER	COLOR TEMP.	LUM.FLUX	L(mm)
18W	3000K	2200 LM	610 mm
	4000K	2400 LM	
27W	3000K	3300 LM	910mm
	4000K	3500 LM	
36W	3000K	4400 LM	1210mm
	4000K	4600 LM	
45W	3000K	5400 LM	1510 mm
	4000K	5600 LM	



82.8mm RECESSED LINEAR

Ral 9005

Ral 9006

Ral 9016

• Tüm RAL seçenekleri / All colors available

CODE : **55.002** RECESSED LINEAR

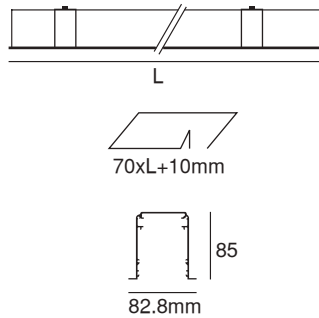

SYS. POWER	COLOR TEMP.	LUM.FLUX	L(mm)
18W	3000K	2200 LM	610 mm
	4000K	2400 LM	
27W	3000K	3300 LM	910mm
	4000K	3500 LM	
36W	3000K	4400 LM	1210mm
	4000K	4600 LM	
45W	3000K	5400 LM	1510 mm
	4000K	5600 LM	



108mm RECESSED LINEAR

Ral 9005

Ral 9006

Ral 9016

• Tüm RAL seçenekleri / All colors available

CODE : **55.003** RECESSED LINEAR

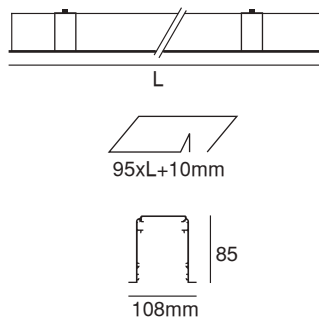

SYS. POWER	COLOR TEMP.	LUM.FLUX	L(mm)
18W	3000K	2200 LM	610 mm
	4000K	2400 LM	
27W	3000K	3300 LM	910mm
	4000K	3500 LM	
36W	3000K	4400 LM	1210mm
	4000K	4600 LM	
45W	3000K	5400 LM	1510 mm
	4000K	5600 LM	



SIVA ÜSTÜ / SARKIT LİNEAR PROFİL surface mounted / suspended system linear profile

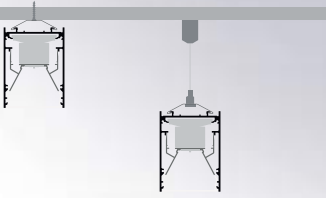

Ekstrüzyon alüminyum profilden üretilmiş armatür gövdesi. 30mm, 50mm, 65mm ve 97mm genişliğinde sürekli aydınlatma sistemleri için tasarlanmış elektrostatik toz boyalı olarak ; beyaz, gri, koyu gri, siyah, bej renkleri dışında istenilen RAL renkleri uygulanabilir.

Sıva üstü uygulama haricinde 1500mm ayarlanabilir sarkıt tel aparatı ile askılı yüzeye kolayca monte edilebilir.

Düzgün aydınlatma için yüksek ışık geçirgenliği ile opal difüzör ile homojen bir ışık sistemine sahiptir. Çok iyi renk verimi ile enerji tasarruflu Led'ler; 2700K, 3000K,4000K ve 6500K renklerinde CRI = 80, Min. 50000 saat ömründe ledler kullanılmaktadır. İsteğe bağlı olarak Dim seçeneği kullanılabilir.

Armature body made of extruded aluminum profile. 30mm, 50mm, 65mm and 97mm wide electrostatic powder coated designed for continuous lighting systems; other RAL colors can be applied except white, gray, dark gray, black and beige colors.

It can be easily mounted on suspended surface with 1500mm adjustable pendant wire bracket except surface mounted application.

It has a homogeneous light system with opal diffuser with high light transmittance for smooth lighting. Energy saving LEDs with very good color efficiency; 2700K, 3000K, 4000K and 6500K colors CRI = 80, Min. LEDs are used in the service life of 50000 hours. Optionally, the Dim option is available.

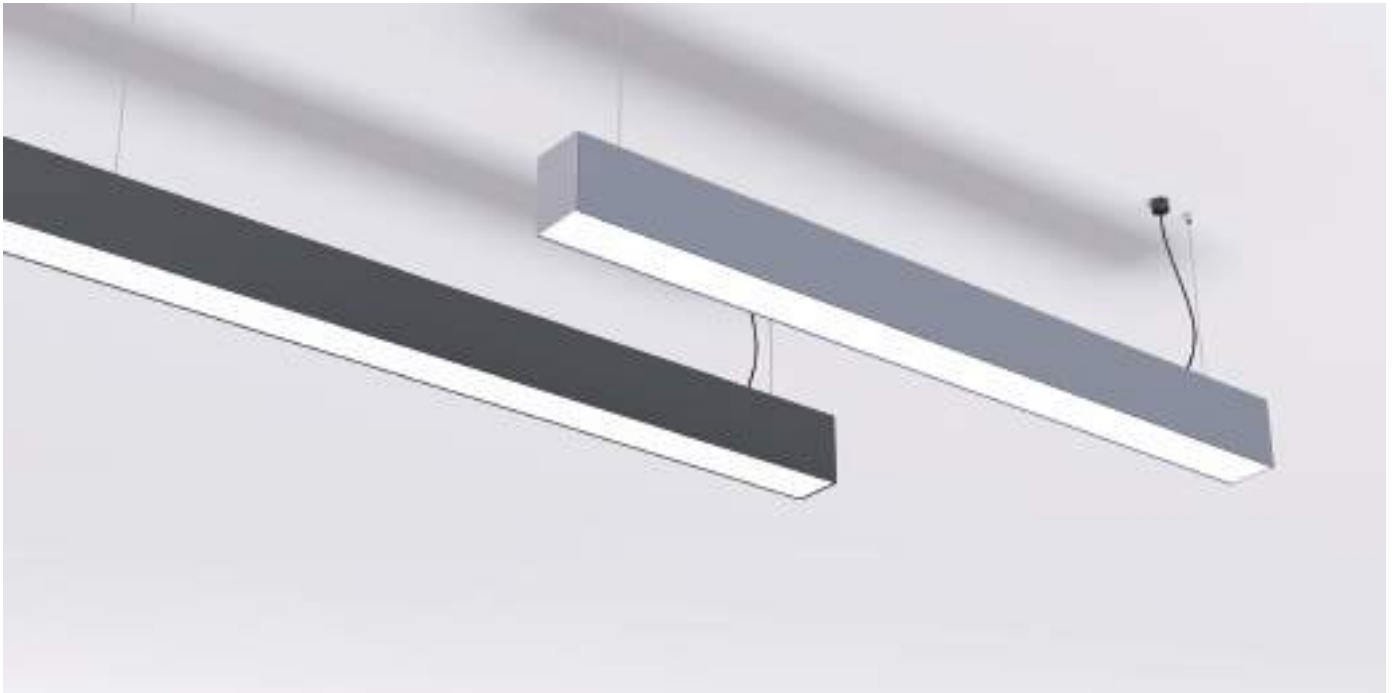



30mm SURFACE & PENDANT

Ral 9005

Ral 9006

Ral 9016

• Tüm RAL seçenekleri / All colors available



30mm SURFACE & PENDANT

Ral 9005

Ral 9006

Ral 9016

• Tüm RAL seçenekleri / All colors available



50mm SURFACE & PENDANT

Ral 9005

Ral 9006

Ral 9016

• Tüm RAL seçenekleri / All colors available



65mm SURFACE & PENDANT

Ral 9005

Ral 9006

Ral 9016

• Tüm RAL seçenekleri / All colors available

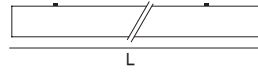
CODE : **54.030** LINEAR

SYS. POWER	COLOR TEMP.	LUM.FLUX	L(mm)
18W	3000K	2200 LM	570 mm
	4000K	2400 LM	
27W	3000K	3300 LM	850 mm
	4000K	3500 LM	
36W	3000K	4400 LM	1150 mm
	4000K	4600 LM	
45W	3000K	5400 LM	1410 mm
	4000K	5600 LM	

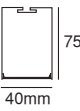
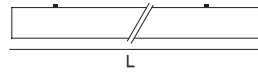
CODE : **54.040** LINEAR

SYS. POWER	COLOR TEMP.	LUM.FLUX	L(mm)
18W	3000K	2200 LM	570 mm
	4000K	2400 LM	
27W	3000K	3300 LM	850 mm
	4000K	3500 LM	
36W	3000K	4400 LM	1150 mm
	4000K	4600 LM	
45W	3000K	5400 LM	1410 mm
	4000K	5600 LM	

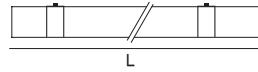
CODE : **54.050** LINEAR

SYS. POWER	COLOR TEMP.	LUM.FLUX	L(mm)
18W	3000K	2200 LM	570 mm
	4000K	2400 LM	
27W	3000K	3300 LM	850 mm
	4000K	3500 LM	
36W	3000K	4400 LM	1150 mm
	4000K	4600 LM	
45W	3000K	5400 LM	1410 mm
	4000K	5600 LM	

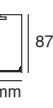
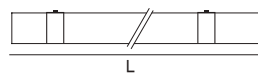
CODE : **54.065** LINEAR

SYS. POWER	COLOR TEMP.	LUM.FLUX	L(mm)
18W	3000K	2200 LM	570 mm
	4000K	2400 LM	
27W	3000K	3300 LM	850 mm
	4000K	3500 LM	
36W	3000K	4400 LM	1150 mm
	4000K	4600 LM	
45W	3000K	5400 LM	1410 mm
	4000K	5600 LM	

SIVA ÜSTÜ / SARKIT LİNEAR PROFİL
surface mounted / suspended system linear profile





65mm SURFACE & PENDANT

Ral 9005

Ral 9006

Ral 9016

• Tüm RAL seçenekleri / All colors available

CODE : **54.097** LINEAR



IP20



SYS. POWER	COLOR TEMP.	LUM.FLUX	L(mm)
18W	3000K	2200 LM	570 mm
	4000K	2400 LM	
27W	3000K	3300 LM	850 mm
	4000K	3500 LM	
36W	3000K	4400 LM	1150 mm
	4000K	4600 LM	
45W	3000K	5400 LM	1410 mm
	4000K	5600 LM	



Sarkıt uygulaması için çelik askı teli
Suspended application



Profile

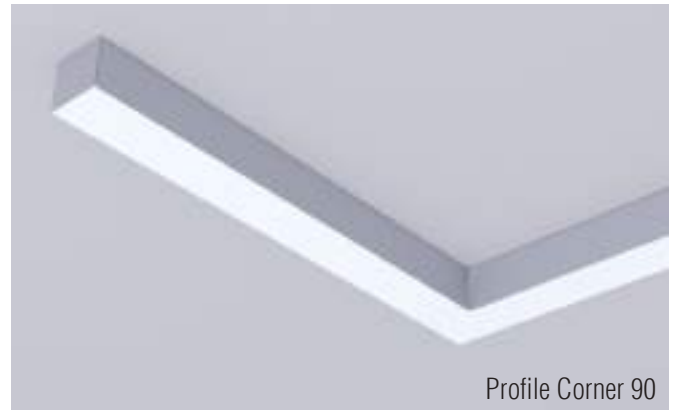

Profile Corner 90

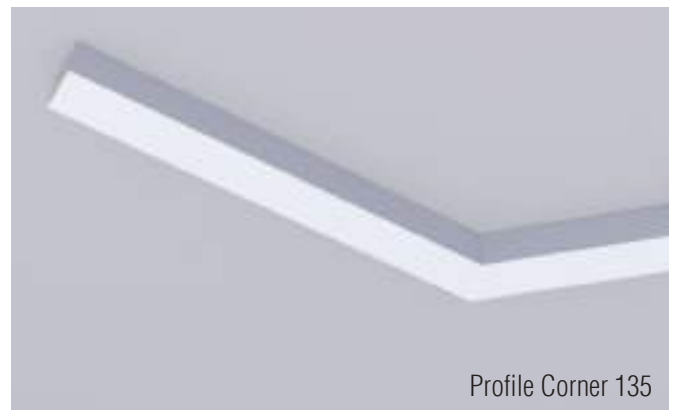

Profile Corner 135



SIVA ÜSTÜ / SARKIT LINEAR PROFİL surface mounted / suspended system linear profile

Ekstrüzyon alüminyum profilden üretilmiş armatür gövdesi. 64mm genişliğinde sürekli aydınlatma sistemleri için tasarlanmış elektrostatik toz boyalı olarak ; beyaz, gri, koyu gri, siyah, bej renkleri dışında istenilen RAL renkleri uygulanabilir.

Sıva üstü uygulama haricinde 1500mm ayarlanabilir sarkıt tel aparatı ile askılı yüzeye kolayca monte edilebilir.

Düzgün aydınlatma için yüksek ışık geçirgenliği yüksek opal difüzör ile homojen bir ışık sistemine sahiptir. Çok iyi renk verimi ile enerji tasarruflu Led'ler; 2700K, 3000K,4000K ve 6500K renklerinde CRI = 80, Min. 50000 saat ömründe ledler kullanılmaktadır. İsteğe bağlı olarak Dim seçeneği kullanılabilir.

Armature body made of extruded aluminum profile. 64mm wide electrostatic powder coated designed for continuous lighting systems; other RAL colors can be applied except white, gray, dark gray, black and beige colors.

It can be easily mounted on suspended surface with 1500mm adjustable pendant wire bracket except surface mounted application.

It has a homogeneous light system with opal diffuser with high light transmittance for smooth lighting. Energy saving LEDs with very good color efficiency; 2700K, 3000K, 4000K and 6500K colors CRI = 80, Min. LEDs are used in the service life of 50000 hours. Optionally, the Dim option is available.



Profile Corner 90



SIVA ÜSTÜ / SARKIT LİNEAR PROFİL / surface mounted / suspended system linear profile

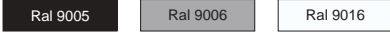

• Tüm RAL seçenekleri / All colors available



Sarkıt uygulaması için çelik askı teli
Suspended application

CODE : **54.010** LINEAR

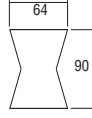

SYS. POWER	COLOR TEMP.	LUM.FLUX	L(mm)
18W	3000K	2200 LM	570 mm
	4000K	2400 LM	
27W	3000K	3300 LM	850 mm
	4000K	3500 LM	
36W	3000K	4400 LM	1150 mm
	4000K	4600 LM	
45W	3000K	5400 LM	1410 mm
	4000K	5600 LM	







SIVA ALTI / TRIMLESS
recessed / trimless

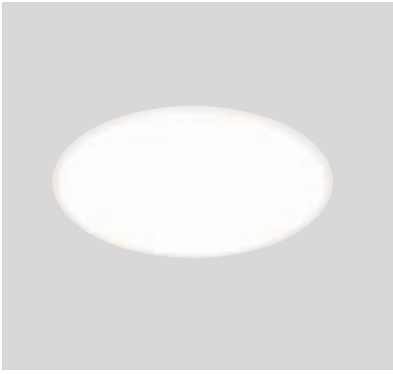

Ral 9005

Ral 9006

Ral 9016

• Tüm RAL seçenekleri / All colors available

DKP gövde
Led driver
Işık geçirgenliği yüksek opal pleksi
Elektrostatik toz boyalı
Opsiyonel Dali (isteğe bağlı)

DKP steel body
Led driver
Opal PMMA difuser.
Electrostatic coating
Optional Dali dim options

CODE : **10.300**

SMD LED modül

15W / 1520 lm.

2700K, 3000K, 4000K

Teknik Çizim / Technical drawing

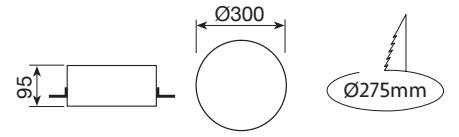

CODE : **10.301**

SMD LED modül

18W / 1820 lm.

2700K, 3000K, 4000K

Teknik Çizim / Technical drawing

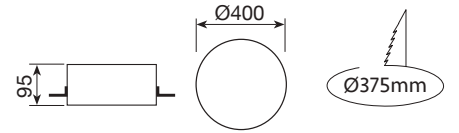

CODE : **10.302**

SMD LED modül

24W / 2710 lm.

2700K, 3000K, 4000K

Teknik Çizim / Technical drawing

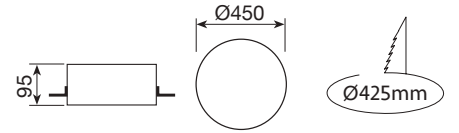

CODE : **10.303**

SMD LED modül

30W / 3380 lm.

2700K, 3000K, 4000K

Teknik Çizim / Technical drawing

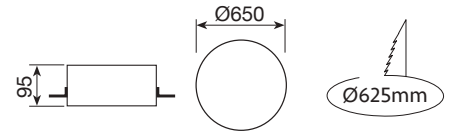

CODE : **10.304**

SMD LED modül

40W / 4500 lm.

2700K, 3000K, 4000K

Teknik Çizim / Technical drawing

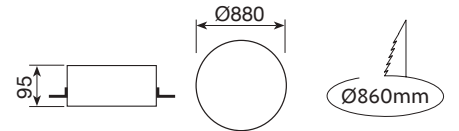

CODE : **10.305**

SMD LED modül

50W / 8630 lm.

2700K, 3000K, 4000K

Teknik Çizim / Technical drawing

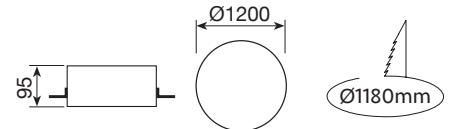

TRIMLESS

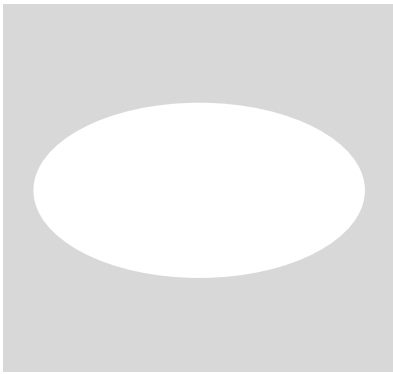

Ral 9005

Ral 9006

Ral 9016

• Tüm RAL seçenekleri / All colors available

Alüminyum gövde
Led driver
Işık geçirgenliği yüksek opal pleksi
Elektrostatik toz boyalı
Opsiyonel Dali (isteğe bağlı)

Aluminium body
Led driver
Opal PMMA difuser.
Electrostatic coating
Optional Dali dim options

CODE : **15.001**

SMD LED modül

15W / 1520 lm.

2700K, 3000K, 4000K

Teknik Çizim / Technical drawing

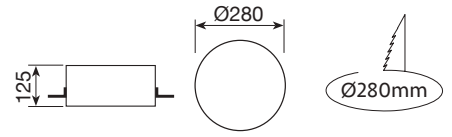

CODE : **15.002**

SMD LED modül

18W / 1820 lm.

2700K, 3000K, 4000K

Teknik Çizim / Technical drawing

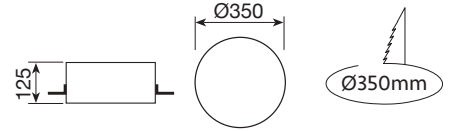

CODE : **15.003**

SMD LED modül

24W / 2710 lm.

2700K, 3000K, 4000K

Teknik Çizim / Technical drawing

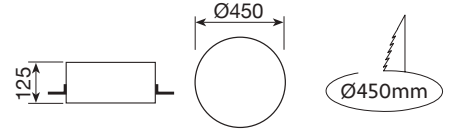

CODE : **15.004**

SMD LED modül

30W / 3380 lm.

2700K, 3000K, 4000K

Teknik Çizim / Technical drawing

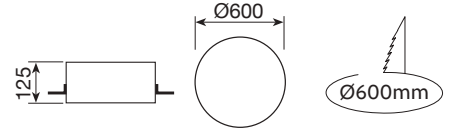

CODE : **15.005**

SMD LED modül

40W / 4500 lm.

2700K, 3000K, 4000K

Teknik Çizim / Technical drawing

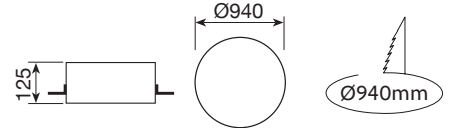

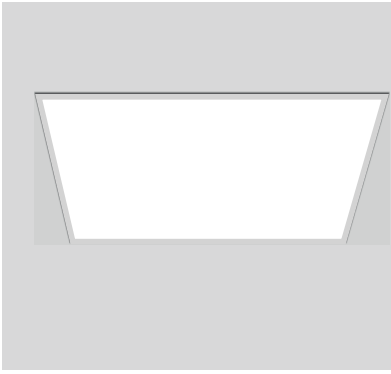
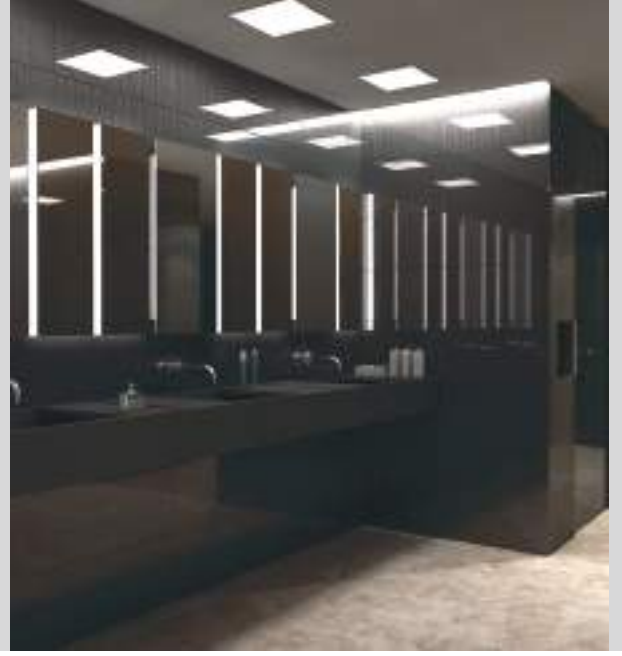
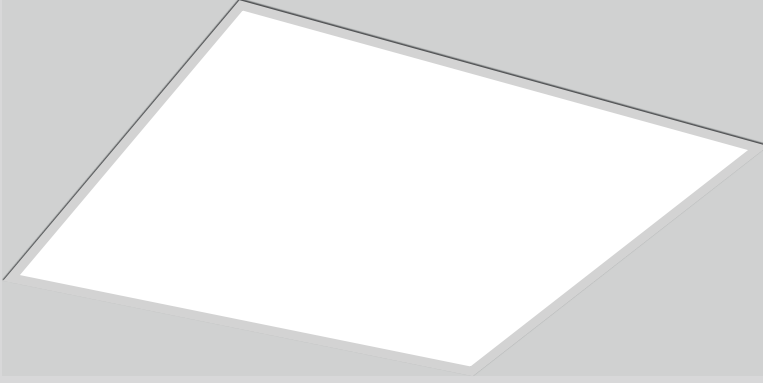

CODE : **11.300**

SMD LED modül

8W / 810 lm.

2700K, 3000K, 4000K

Teknik Çizim / Technical drawing

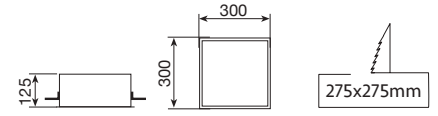

CODE : **11.301**

SMD LED modül

18W / 1820 lm.

2700K, 3000K, 4000K

Teknik Çizim / Technical drawing

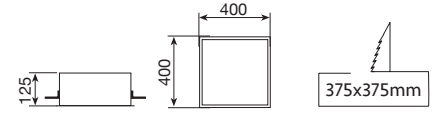

  IP20

Ral 9005

Ral 9006

Ral 9016

• Tüm RAL seçenekleri / All colors available

Alüminyum gövde
Led driver
Işık geçirgenliği yüksek opal pleksi
Elektrostatik toz boyalı
Opsiyonel Dali (isteğe bağlı)

Aluminium body
Led driver
Opal PMMA difuser.
Electrostatic coating
Optional Dali dim options

CODE : **11.302**

SMD LED modül

24W / 2710 lm.

2700K, 3000K, 4000K

Teknik Çizim / Technical drawing

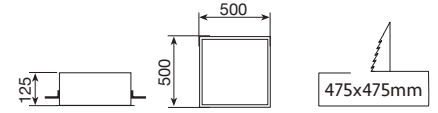

CODE : **11.303**

SMD LED modül

30W / 3380 lm.

2700K, 3000K, 4000K

Teknik Çizim / Technical drawing

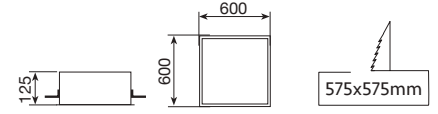

CODE : **11.304**

SMD LED modül

18W / 1820 lm.

2700K, 3000K, 4000K

Teknik Çizim / Technical drawing

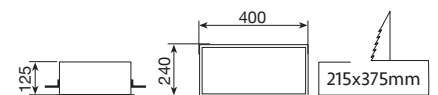

CODE : **11.305**

SMD LED modül

24W / 2710 lm.

2700K, 3000K, 4000K

Teknik Çizim / Technical drawing

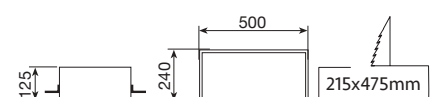

TRIMLESS



Ral 9005

Ral 9006

Ral 9016

• Tüm RAL seçenekleri / All colors available

Alüminyum gövde
Led driver
Işık geçirgenliği yüksek opal pleksi
Elektrostatik toz boyalı
Opsiyonel Dali (isteğe bağlı)

Aluminium body
Led driver
Opal PMMA difuser.
Electrostatic coating
Optional Dali dim options

CODE : **15.010**

SMD LED modül

8W / 810 lm.

2700K, 3000K, 4000K

Teknik Çizim / Technical drawing

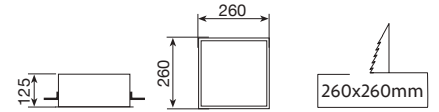

CODE : **15.011**

SMD LED modül

18W / 1820 lm.

2700K, 3000K, 4000K

Teknik Çizim / Technical drawing

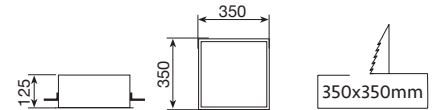

CODE : **15.012**

SMD LED modül

24W / 2710 lm.

2700K, 3000K, 4000K

Teknik Çizim / Technical drawing

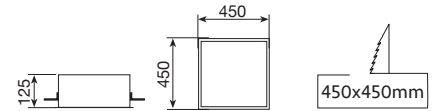

CODE : **15.013**

SMD LED modül

30W / 3380 lm.

2700K, 3000K, 4000K

Teknik Çizim / Technical drawing

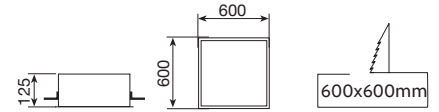

CODE : **15.014**

SMD LED modül

18W / 1820 lm.

2700K, 3000K, 4000K

Teknik Çizim / Technical drawing

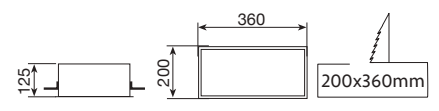

CODE : **15.015**

SMD LED modül

24W / 2710 lm.

2700K, 3000K, 4000K

Teknik Çizim / Technical drawing

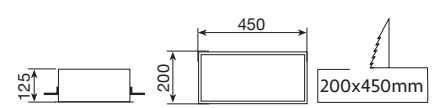

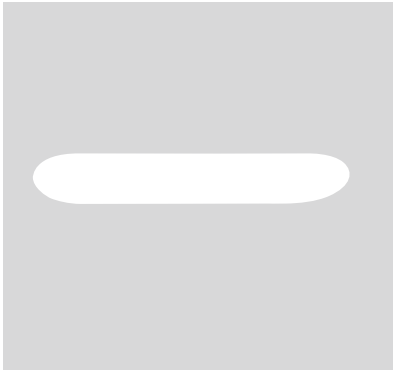
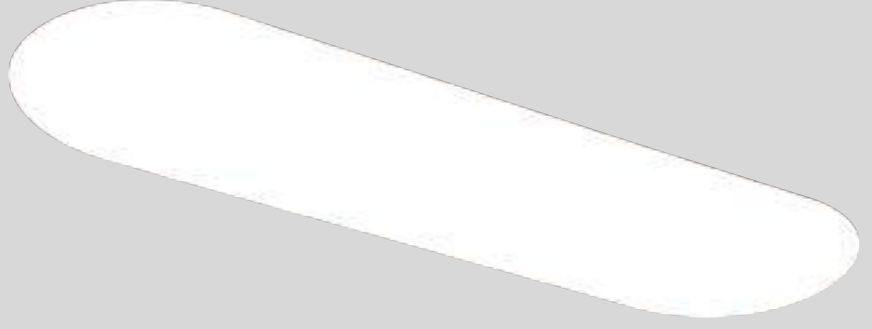

CE IP20

Ral 9005

Ral 9006

Ral 9016

• Tüm RAL seçenekleri / All colors available

Alüminyum gövde
Led driver
Işık geçirgenliği yüksek opal pleksi
Elektrostatik toz boyalı
Opsiyonel Dali (isteğe bağlı)

Aluminium body
Led driver
Opal PMMA difuser.
Electrostatic coating
Optional Dali dim options

CODE : **15.020**

SMD LED modül

13W / 1315 lm.

2700K, 3000K, 4000K

Teknik Çizim / Technical drawing

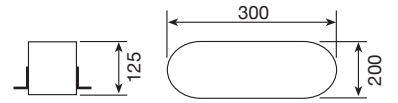

CODE : **15.021**

SMD LED modül

16W / 1620 lm.

2700K, 3000K, 4000K

Teknik Çizim / Technical drawing

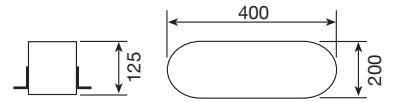

CODE : **15.022**

SMD LED modül

20W / 2025 lm.

2700K, 3000K, 4000K

Teknik Çizim / Technical drawing

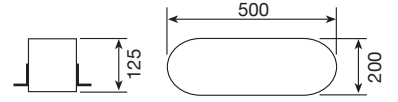

CODE : **15.023**

SMD LED modül

35W / 2530 lm.

2700K, 3000K, 4000K

Teknik Çizim / Technical drawing

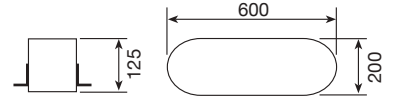



TRIMLESS

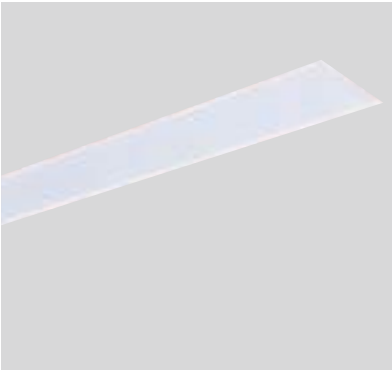

CODE : **15.200**

SMD LED modül

10W / 15W / 20 W / 25W

1200lm./1800 lm./2400 lm./3000 lm.

2700K, 3000K, 4000K

Teknik Çizim / Technical drawing

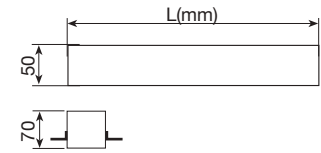

Power	L	DxE (mm)
10W	600mm	600x50
15W	900mm	900x50
20W	1200mm	1200x50
25W	1500mm	1500x50



Ral 9005

Ral 9006

Ral 9016

• Tüm RAL seçenekleri / All colors available

Alüminyum gövde

Led driver

Işık geçirgenliği yüksek opal pleksi

Elektrostatik toz boyalı

Opsiyonel Dali (isteğe bağlı)

Aluminium body

Led driver

Opal PMMA difuser.

Electrostatic coating

Optional Dali dim options

CODE : **15.201**

SMD LED modül

10W / 15W / 20 W / 25W

1200lm./1800 lm./2400 lm./3000 lm.

2700K, 3000K, 4000K

Teknik Çizim / Technical drawing

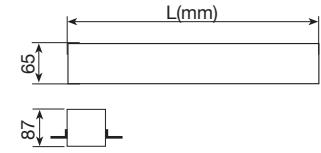

Power	L	DxE (mm)
10W	600mm	600x65
15W	900mm	900x65
20W	1200mm	1200x65
25W	1500mm	1500x65

CODE : **15.202**

SMD LED modül

10W / 15W / 20 W / 25W

1200lm./1800 lm./2400 lm./3000 lm.

2700K, 3000K, 4000K

Teknik Çizim / Technical drawing

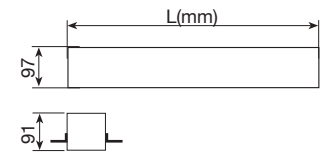

Power	L	DxE (mm)
10W	600mm	600x97
15W	900mm	900x97
20W	1200mm	1200x97
25W	1500mm	1500x97

TRIMLESS



• Tüm RAL seçenekleri / All colors available

CODE : **15.105**

SMD LED modül

40W / 5200 lm

2700K, 3000K, 4000K

Teknik Çizim / Technical drawing

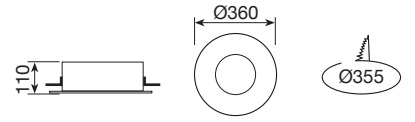

Alüminyum gövde

Led driver

Işık geçirgenliği yüksek opal pleksi

Elektrostatik toz boyalı

Opsiyonel DALI (isteğe bağlı)

Aluminium body

Led driver

Opal PMMA difuser.

Electrostatic coating

Optional DALI dim options



CODE : **10.200**

GU10 LED

5.5W / 370 lm

2700K, 3000K, 4000K

Alüminyum profil
Metal Gövde
Elektrostatik toz boyalı
Opsiyonel Dali (isteğe bağlı)

Aluminium profile
Metal body
Electrostatic coating
Optional Dali dim options

Teknik Çizim / Technical drawing

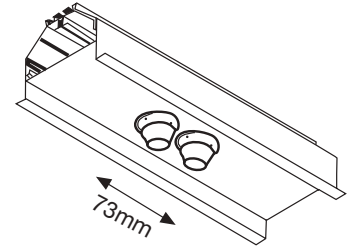
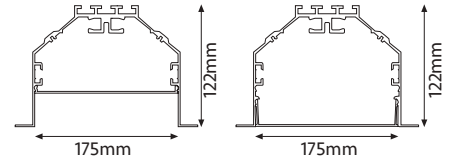

CE IP20

Ral 9005

Ral 9006

Ral 9016

• Tüm RAL seçenekleri / All colors available



CODE : **10.201**

AR111 LED

15W / 100 lm

2700K, 3000K, 4000K

Alüminyum profil
Metal Gövde
Elektrostatik toz boyalı
Opsiyonel Dali (isteğe bağlı)

Aluminium profile
Metal body
Electrostatic coating
Optional Dali dim options

Teknik Çizim / Technical drawing

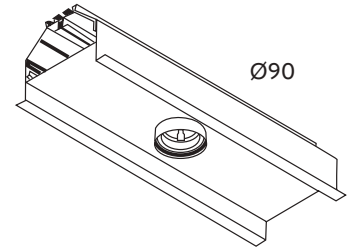
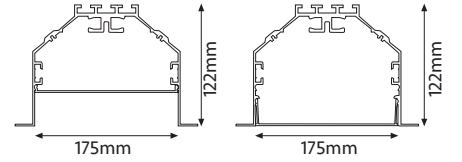

CE IP20

Ral 9005

Ral 9006

Ral 9016

• Tüm RAL seçenekleri / All colors available



CODE : **10.202**

LED

24W / 1576 lm.

2700K, 3000K, 4000K

Teknik Çizim / Technical drawing

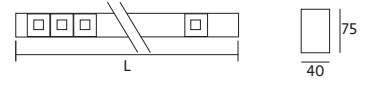

Alüminyum profil
Elektrostatik toz boyalı
Opsiyonel Dali (isteğe bağlı)

Aluminium profile
Electrostatic coating
Optional Dali dim options

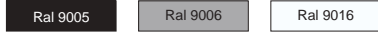

• Tüm RAL seçenekleri / All colors available

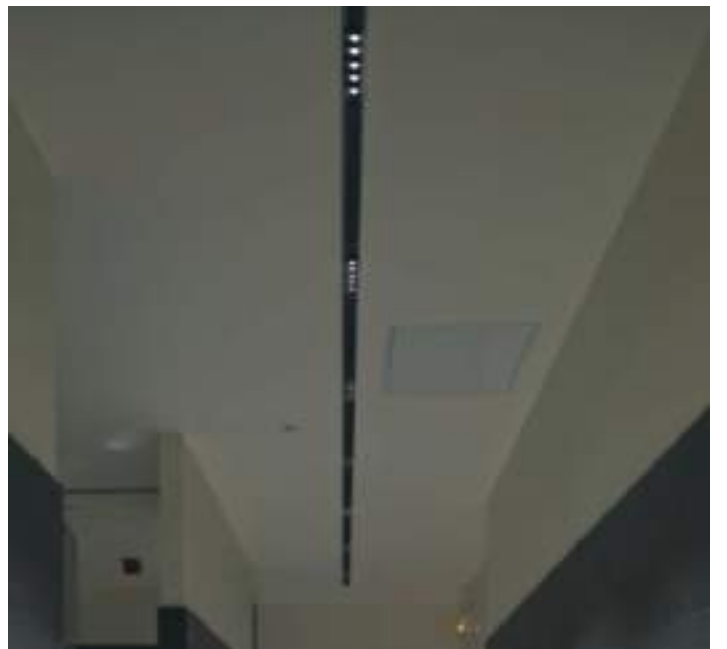



CODE : **SA 15.045**

COB LED modül

8W / 1000 lm.

2700K, 3000K, 4000K

Alüminyum enjeksiyon gövde

Alüminyum led soğutucu

Led driver

Isıya dayanıklı cam

Yüksek saflıkta alüminyum reflektör

Dar, orta ve geniş açılı reflektör seçeneği

Elektrostatik toz boyalı

Die-cast aluminium body

Aluminium heatsink

Led driver

Tempered glass

High purity aluminium reflector

Narrow, Medium and Wide angle reflectors

Electrostatic coating

Teknik Çizim / Technical drawing

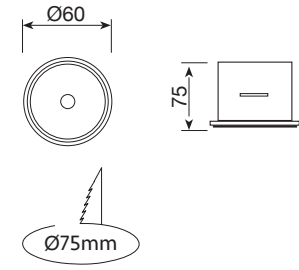

CE IP20

Ral 9005

Ral 9006

Ral 9016

• Tüm RAL seçenekleri / All colors available

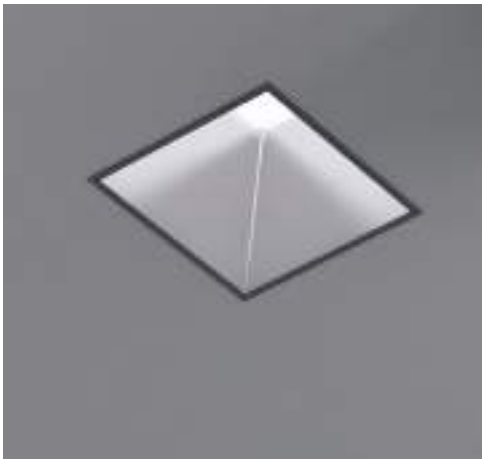
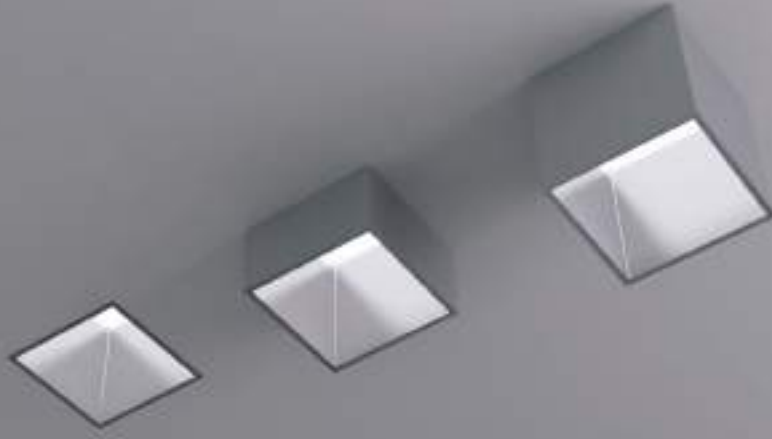

CODE : **SA 15.046**

COB LED modül

8W 1000 lm.

2700K, 3000K, 4000K

Alüminyum enjeksiyon gövde

Alüminyum led soğutucu

Led driver

Yüksek saflıkta alüminyum reflektör

Dar, orta ve geniş açılı reflektör seçeneği

Elektrostatik toz boyalı

Die-cast aluminium body

Aluminium heatsink

Led driver

High purity aluminium reflector

Narrow, Medium and Wide angle reflectors

Electrostatic coating

Teknik Çizim / Technical drawing

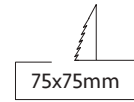
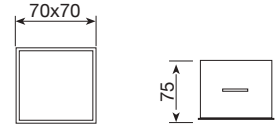



CE IP20

Ral 9005

Ral 9006

Ral 9016

• Tüm RAL seçenekleri / All colors available

CODE : **SA 18.045**

COB LED modül

8W / 1000 lm.

2700K, 3000K, 4000K

Alüminyum enjeksiyon gövde
Alüminyum led soğutucu
Led driver
Isıya dayanıklı cam
Yüksek saflıkta alüminyum reflektör
Dar, orta ve geniş açılı reflektör seçeneği
Elektrostatik toz boyalı

Die-cast aluminium body
Aluminium heatsink
Led driver
Tempered glass
High purity aluminium reflector
Narrow, Medium and Wide angle reflectors
Electrostatic coating

Teknik Çizim / Technical drawing

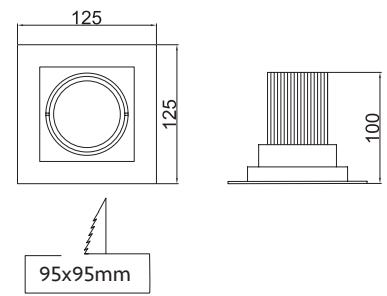

CE IP20

Ral 9005

Ral 9006

Ral 9016

• Tüm RAL seçenekleri / All colors available

CODE : **TRM 18.045**

COB LED modül

8W / 1000 lm.

2700K, 3000K, 4000K

Alüminyum enjeksiyon gövde
Alüminyum led soğutucu
Led driver
Isıya dayanıklı cam
Yüksek saflıkta alüminyum reflektör
Dar, orta ve geniş açılı reflektör seçeneği
Elektrostatik toz boyalı

Die-cast aluminium body
Aluminium heatsink
Led driver
Tempered glass
High purity aluminium reflector
Narrow, Medium and Wide angle reflectors
Electrostatic coating

Teknik Çizim / Technical drawing

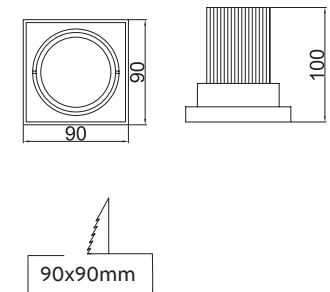







CODE : **SA 15.046**

COB LED modül

16W 2000 lm.

2700K, 3000K, 4000K

Alüminyum enjeksiyon gövde
Alüminyum led soğutucu
Led driver
Yüksek saflıkta alüminyum reflektör
Dar, orta ve geniş açılı reflektör seçeneği
Elektrostatik toz boyalı

Die-cast aluminium body
Aluminium heatsink
Led driver
High purity aluminium reflector
Narrow, Medium and Wide angle reflectors
Electrostatic coating

Teknik Çizim / Technical drawing

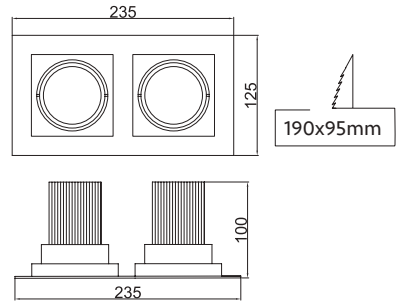

CODE : **TRM 15.046**

COB LED modül

8W / 1000 lm.

2700K, 3000K, 4000K

Alüminyum enjeksiyon gövde
Alüminyum led soğutucu
Led driver
Isıya dayanıklı cam
Yüksek saflıkta alüminyum reflektör
Dar, orta ve geniş açılı reflektör seçeneği
Elektrostatik toz boyalı

Die-cast aluminium body
Aluminium heatsink
Led driver
Tempered glass
High purity aluminium reflector
Narrow, Medium and Wide angle reflectors
Electrostatic coating

Teknik Çizim / Technical drawing

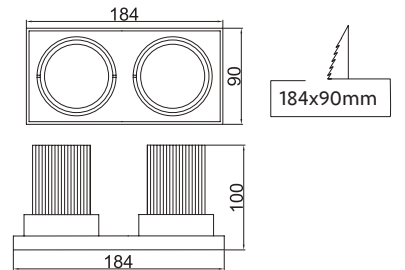

CE IP20

Ral 9005

Ral 9006

Ral 9016

• Tüm RAL seçenekleri / All colors available



CODE : **TRM 15.081**

COB LED modül

8W / 1000 lm.

2700K, 3000K, 4000K

Teknik Çizim / Technical drawing

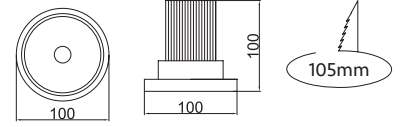

Alüminyum enjeksiyon gövde
Alüminyum led soğutucu
Led driver
Isıya dayanıklı cam
Yüksek saflıkta alüminyum reflektör
Dar, orta ve geniş açılı reflektör seçeneği
Elektrostatik toz boyalı

Die-cast aluminium body
Aluminium heatsink
Led driver
Tempered glass
High purity aluminium reflector
Narrow, Medium and Wide angle reflectors
Electrostatic coating

CODE : **TRM 15.082**

COB LED modül

16W / 2000 lm.

2700K, 3000K, 4000K

Teknik Çizim / Technical drawing

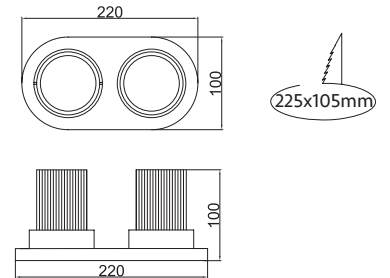

Alüminyum enjeksiyon gövde
Alüminyum led soğutucu
Led driver
Isıya dayanıklı cam
Yüksek saflıkta alüminyum reflektör
Dar, orta ve geniş açılı reflektör seçeneği
Elektrostatik toz boyalı

Die-cast aluminium body
Aluminium heatsink
Led driver
Tempered glass
High purity aluminium reflector
Narrow, Medium and Wide angle reflectors
Electrostatic coating

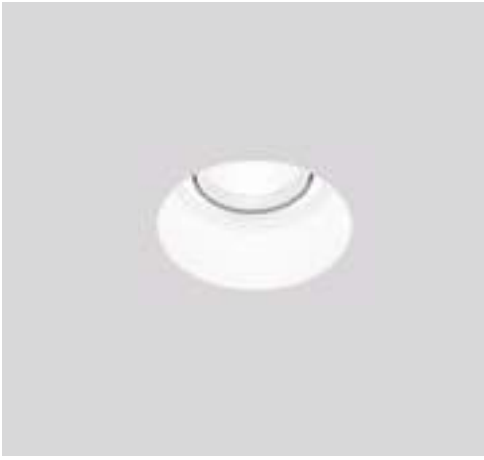

CE IP20

Ral 9005

Ral 9006

Ral 9016

• Tüm RAL seçenekleri / All colors available



CE IP20

Ral 9005

Ral 9006

Ral 9016

• Tüm RAL seçenekleri / All colors available



CODE : **SA 10.425**

GU10 LED

2x5.5W / 2x370 lm.

2700K, 3000K, 4000K

Alüminyum enjeksiyon gövde
Dar, orta ve geniş açılı reflektör seçeneği
Elektrostatik toz boyalı

Die-cast aluminium body
Narrow, Medium and Wide angle reflectors
Electrostatic coating

Teknik Çizim / Technical drawing

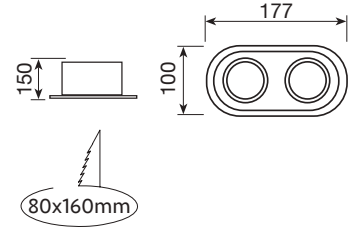

□ CE IP20

Ral 9005

Ral 9006

Ral 9016

• Tüm RAL seçenekleri / All colors available

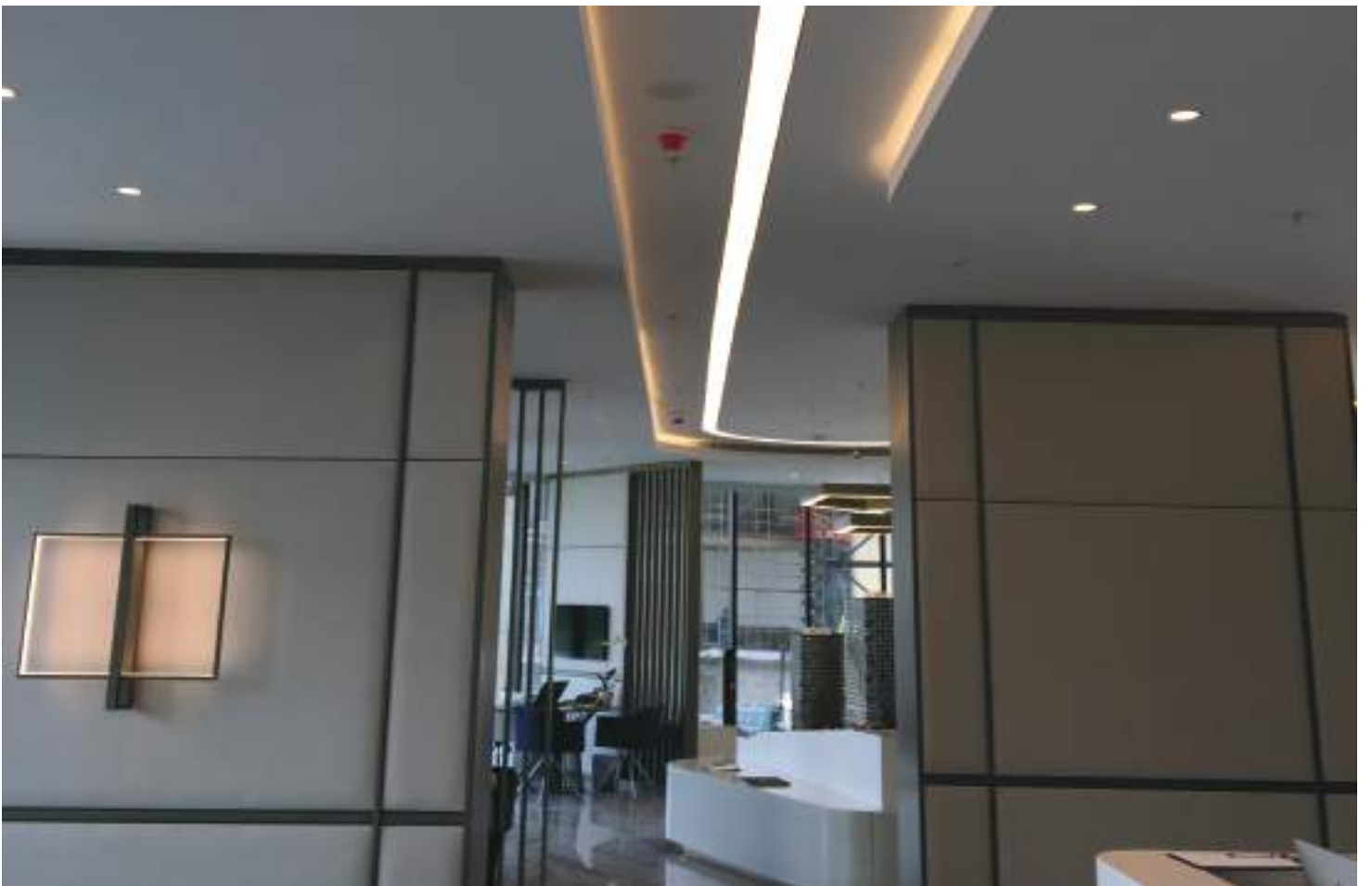



CODE : **SA 11.050**

COB LED modül

8W 1000 lm.

2700K, 3000K, 4000K

Alüminyum enjeksiyon gövde
Alüminyum led soğutucu
Led driver
Yüksek saflıkta alüminyum reflektör
Dar, orta ve geniş açılı reflektör seçeneği
Elektrostatik toz boyalı

Die-cast aluminium body
Aluminium heatsink
Led driver
High purity aluminium reflector
Narrow, Medium and Wide angle reflectors
Electrostatic coating

Teknik Çizim / Technical drawing

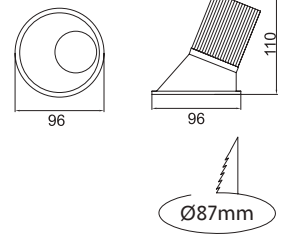

CODE : **SA 10.300**

COB LED modül

2W / 200 lm.

2700K, 3000K, 4000K

Alüminyum enjeksiyon gövde
Alüminyum led soğutucu
Led driver
Elektrostatik toz boyalı

Die-cast aluminium body
Aluminium heatsink
Led driver
Electrostatic coating

Teknik Çizim / Technical drawing

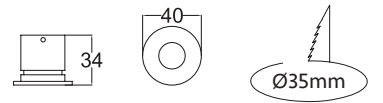



CODE : **SA 11.075**

COB LED modül

8W / 1100 lm.

2700K, 3000K, 4000K

Alüminyum enjeksiyon gövde
Alüminyum led soğutucu
Led driver
Isıya dayanıklı cam
Yüksek saflıkta alüminyum reflektör
Dar, orta ve geniş açılı reflektör seçeneği
Elektrostatik toz boyalı

Die-cast aluminium body
Aluminium heatsink
Led driver
Tempered glass
High purity aluminium reflector
Narrow, Medium and Wide angle reflectors
Electrostatic coating

Teknik Çizim / Technical drawing

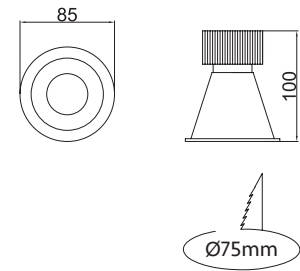

CE IP20

Ral 9005

Ral 9006

Ral 9016

• Tüm RAL seçenekleri / All colors available

CODE : **SA 15.060**

COB LED modül

30W / 3300 lm.

2700K, 3000K, 4000K

Alüminyum enjeksiyon gövde
Alüminyum led soğutucu
Led driver
Isıya dayanıklı cam
Yüksek saflıkta alüminyum reflektör
Dar, orta ve geniş açılı reflektör seçeneği
Elektrostatik toz boyalı

Die-cast aluminium body
Aluminium heatsink
Led driver
Tempered glass
High purity aluminium reflector
Narrow, Medium and Wide angle reflectors
Electrostatic coating

Teknik Çizim / Technical drawing

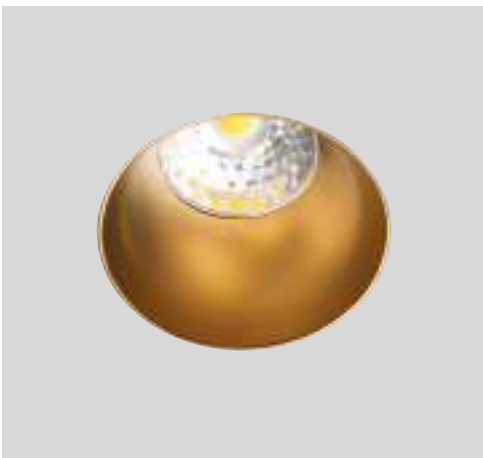
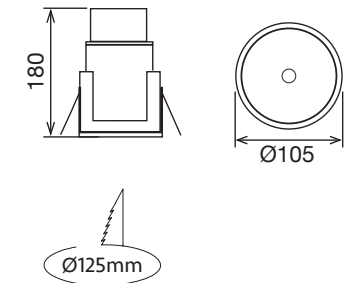

CE IP20

Ral 9005

Ral 9006

Ral 9016

• Tüm RAL seçenekleri / All colors available



CODE : **SA 15.040**

COB LED modül

20W 2500 lm.

2700K, 3000K, 4000K

Alüminyum enjeksiyon gövde
Alüminyum led soğutucu
Led driver
Yüksek saflıkta alüminyum reflektör
Dar, orta ve geniş açılı reflektör seçeneği
Elektrostatik toz boyalı

Die-cast aluminium body
Aluminium heatsink
Led driver
High purity aluminium reflector
Narrow, Medium and Wide angle reflectors
Electrostatic coating

Teknik Çizim / Technical drawing

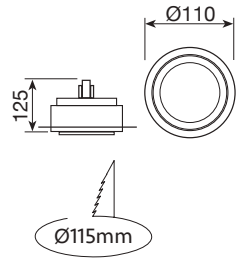

CODE : **SA 15.041**

COB LED modül

30W / 3750 lm.

2700K, 3000K, 4000K

Alüminyum enjeksiyon gövde
Alüminyum led soğutucu
Led driver
Isıya dayanıklı cam
Yüksek saflıkta alüminyum reflektör
Dar, orta ve geniş açılı reflektör seçeneği
Elektrostatik toz boyalı

Die-cast aluminium body
Aluminium heatsink
Led driver
Tempered glass
High purity aluminium reflector
Narrow, Medium and Wide angle reflectors
Electrostatic coating

Teknik Çizim / Technical drawing

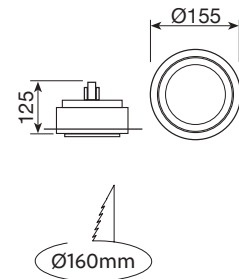

CE IP20

Ral 9005

Ral 9006

Ral 9016

• Tüm RAL seçenekleri / All colors available



CODE : **SA 10.430**

COB LED modül

8W / 1000 lm.

2700K, 3000K, 4000K

Alüminyum enjeksiyon gövde

Alüminyum led soğutucu

Led driver

Yüksek saflıkta alüminyum reflektör

Dar, orta ve geniş açılı reflektör seçeneği

Elektrostatik toz boyalı

Die-cast aluminium body

Aluminium heatsink

Led driver

High purity aluminium reflector

Narrow, Medium and Wide angle reflectors

Electrostatic coating

Teknik Çizim / Technical drawing

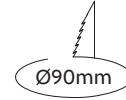
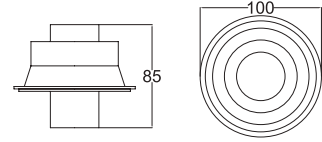

CE IP20

Ral 9005

Ral 9006

Ral 9016

• Tüm RAL seçenekleri / All colors available



CE IP20

Ral 9005

Ral 9006

Ral 9016

• Tüm RAL seçenekleri / All colors available

CODE : **SA 12.040**

COB LED modül

18W / 2250 lm.

2700K, 3000K, 4000K

Alüminyum enjeksiyon gövde
Alüminyum led soğutucu
Led driver
Yüksek saflıkta alüminyum reflektör
Dar, orta ve geniş açılı reflektör seçeneği
Elektrostatik toz boyalı

Die-cast aluminium body
Aluminium heatsink
Led driver
High purity aluminium reflector
Narrow, Medium and Wide angle reflectors
Electrostatic coating

Teknik Çizim / Technical drawing

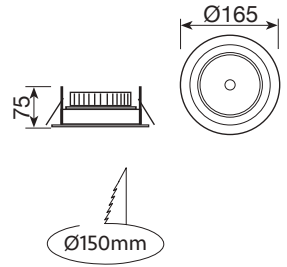



Alüminyum enjeksiyon gövde
Alüminyum led soğutucu
Led driver
Yüksek saflıkta alüminyum reflektör
Dar, orta ve geniş açılı reflektör seçeneği
Elektrostatik toz boyalı

Die-cast aluminium body
Aluminium heatsink
Led driver
High purity aluminium reflector
Narrow, Medium and Wide angle reflectors
Electrostatic coating



Ral 9005

Ral 9006

Ral 9016

• Tüm RAL seçenekleri / All colors available

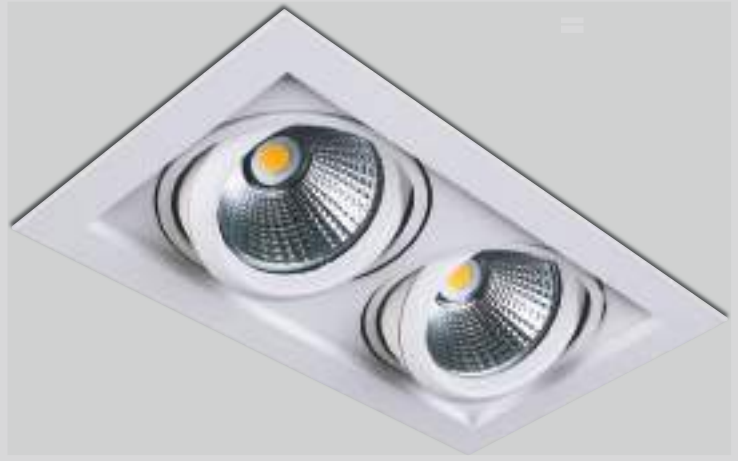

CODE : **SA 12.030**

COB LED modül

18W / 2250 lm.

2700K, 3000K, 4000K

Teknik Çizim / Technical drawing

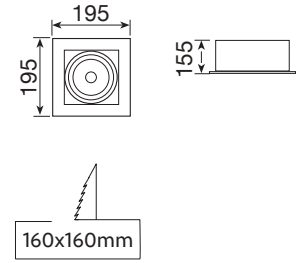

CODE : **SA 12.031**

COB LED modül

2x18W / 2x2250 lm.

2700K, 3000K, 4000K

Teknik Çizim / Technical drawing

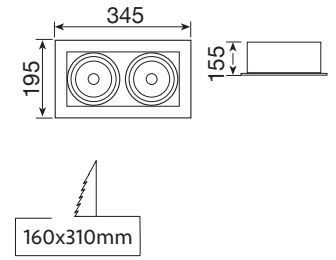

CODE : **SA 12.032**

COB LED modül

3x18W / 3x2250 lm.

2700K, 3000K, 4000K

Teknik Çizim / Technical drawing

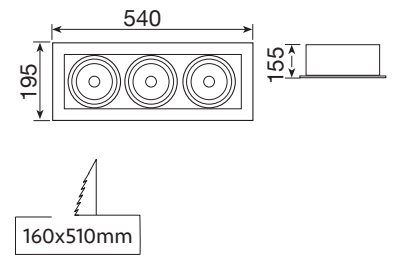



CODE : **SA 10.097**

COB LED modül

10W / 1200 lm.

2700K, 3000K, 4000K

Alüminyum enjeksiyon gövde
Alüminyum led soğutucu
Led driver
Yüksek saflıkta alüminyum reflektör
Dar, orta ve geniş açılı reflektör seçeneği
Elektrostatik toz boyalı

Die-cast aluminium body
Aluminium heatsink
Led driver
High purity aluminium reflector
Narrow, Medium and Wide angle reflectors
Electrostatic coating

Teknik Çizim / Technical drawing

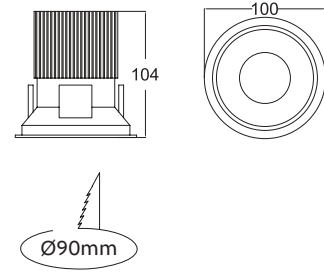

CE IP20

Ral 9005

Ral 9006

Ral 9016

• Tüm RAL seçenekleri / All colors available

CODE : **SA 10.400**

COB LED modül

8W / 1000 lm.

2700K, 3000K, 4000K

Alüminyum enjeksiyon gövde
Alüminyum led soğutucu
Led driver
Yüksek saflıkta alüminyum reflektör
Dar, orta ve geniş açılı reflektör seçeneği
Elektrostatik toz boyalı

Die-cast aluminium body
Aluminium heatsink
Led driver
High purity aluminium reflector
Narrow, Medium and Wide angle reflectors
Electrostatic coating

Teknik Çizim / Technical drawing

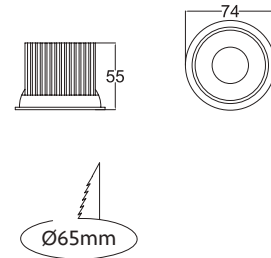

CE IP20

Ral 9005

Ral 9006

Ral 9016

• Tüm RAL seçenekleri / All colors available



CODE : **SA 11.050**

COB LED modül

8W 1000 lm.

2700K, 3000K, 4000K

Alüminyum enjeksiyon gövde
Alüminyum led soğutucu
Led driver
Yüksek saflıkta alüminyum reflektör
Dar, orta ve geniş açılı reflektör seçeneği
Elektrostatik toz boyalı

Die-cast aluminium body
Aluminium heatsink
Led driver
High purity aluminium reflector
Narrow, Medium and Wide angle reflectors
Electrostatic coating

Teknik Çizim / Technical drawing

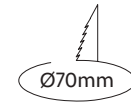
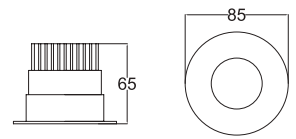

CODE : **SA 10.054**

COB LED modül

8W / 1000 lm.

2700K, 3000K, 4000K

Alüminyum enjeksiyon gövde
Alüminyum led soğutucu
Led driver
Yüksek saflıkta alüminyum reflektör
Dar, orta ve geniş açılı reflektör seçeneği
Elektrostatik toz boyalı

Die-cast aluminium body
Aluminium heatsink
Led driver
High purity aluminium reflector
Narrow, Medium and Wide angle reflectors
Electrostatic coating

Teknik Çizim / Technical drawing

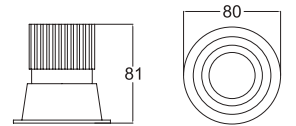



CODE : **SA 14.043**

COB LED modül

10W / 1200 lm.

2700K, 3000K, 4000K

Alüminyum enjeksiyon gövde
Alüminyum led soğutucu
Led driver
Yüksek saflıkta alüminyum reflektör
Dar, orta ve geniş açılı reflektör seçeneği
Elektrostatik toz boyalı

Die-cast aluminium body
Aluminium heatsink
Led driver
High purity aluminium reflector
Narrow, Medium and Wide angle reflectors
Electrostatic coating

Teknik Çizim / Technical drawing

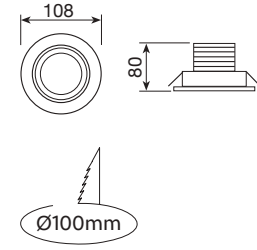

CE IP20

Ral 9005

Ral 9006

Ral 9016

• Tüm RAL seçenekleri / All colors available



CODE : **SA 12.044**

COB LED modül

2x10W / 2400 lm.

2700K, 3000K, 4000K

Alüminyum enjeksiyon gövde
Alüminyum led soğutucu
Led driver
Yüksek saflıkta alüminyum reflektör
Dar, orta ve geniş açılı reflektör seçeneği
Elektrostatik toz boyalı

Die-cast aluminium body
Aluminium heatsink
Led driver
High purity aluminium reflector
Narrow, Medium and Wide angle reflectors
Electrostatic coating

Teknik Çizim / Technical drawing

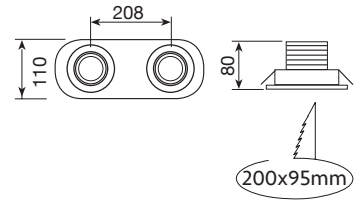

CE IP20

Ral 9005

Ral 9006

Ral 9016

• Tüm RAL seçenekleri / All colors available



CODE : **SA 11.078**

COB LED modül

8W / 1000 lm.

2700K, 3000K, 4000K

Alüminyum enjeksiyon gövde
Alüminyum led soğutucu
Led driver
Yüksek saflıkta alüminyum reflektör
Dar, orta ve geniş açılı reflektör seçeneği
Elektrostatik toz boyalı

Die-cast aluminium body
Aluminium heatsink
Led driver
High purity aluminium reflector
Narrow, Medium and Wide angle reflectors
Electrostatic coating

Teknik Çizim / Technical drawing

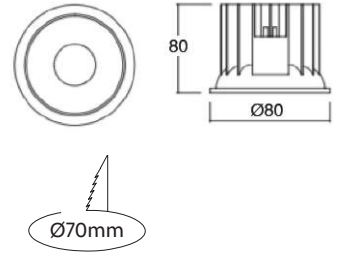

  IP20

Ral 9005

Ral 9006

Ral 9016

• Tüm RAL seçenekleri / All colors available

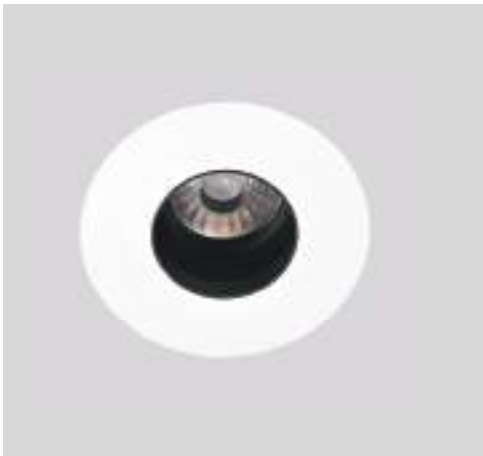

CODE : **SA 15.300**

COB LED modül

10W / 1200 lm.

2700K, 3000K, 4000K

Alüminyum enjeksiyon gövde
Alüminyum led soğutucu
Led driver
Yüksek saflıkta alüminyum reflektör
Dar, orta ve geniş açılı reflektör seçeneği
Elektrostatik toz boyalı

Die-cast aluminium body
Aluminium heatsink
Led driver
High purity aluminium reflector
Narrow, Medium and Wide angle reflectors
Electrostatic coating

Teknik Çizim / Technical drawing

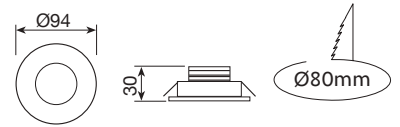

  IP20

Ral 9005

Ral 9006

Ral 9016

• Tüm RAL seçenekleri / All colors available



CODE : **SA 10.410**

COB LED modül

2x10W / 2x1200 lm.

2700K, 3000K, 4000K

Alüminyum enjeksiyon gövde

Alüminyum led soğutucu

Led driver

Yüksek saflıkta alüminyum reflektör

Dar, orta ve geniş açılı reflektör seçeneği

Elektrostatik toz boyalı

Die-cast aluminium body

Aluminium heatsink

Led driver

High purity aluminium reflector

Narrow, Medium and Wide angle reflectors

Electrostatic coating

Teknik Çizim / Technical drawing

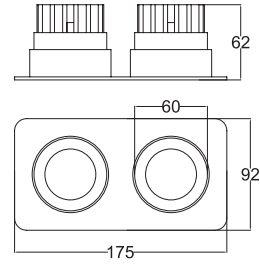

CE IP20

Ral 9005

Ral 9006

Ral 9016

• Tüm RAL seçenekleri / All colors available



CODE : **SA 10.415**

COB LED modül

15W / 1800 lm.

2700K, 3000K, 4000K

Alüminyum enjeksiyon gövde

Alüminyum led soğutucu

Led driver

Yüksek saflıkta alüminyum reflektör

Dar, orta ve geniş açılı reflektör seçeneği

Elektrostatik toz boyalı

Die-cast aluminium body

Aluminium heatsink

Led driver

High purity aluminium reflector

Narrow, Medium and Wide angle reflectors

Electrostatic coating

Teknik Çizim / Technical drawing

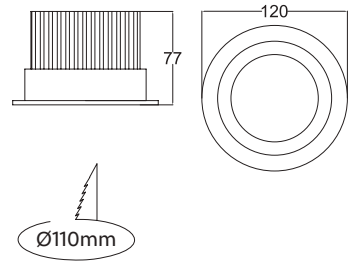



CODE : **SA 10.425**

GU10 LED

5.5W / 370 lm.

2700K, 3000K, 4000K

Alüminyum enjeksiyon gövde
Dar, orta ve geniş açılı reflektör seçeneği
Elektrostatik toz boyalı

Die-cast aluminium body
Narrow, Medium and Wide angle reflectors
Electrostatic coating

Teknik Çizim / Technical drawing

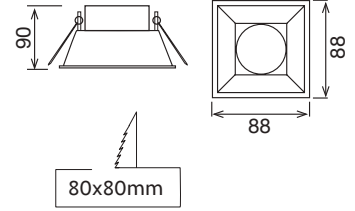

□ CE IP20

Ral 9005

Ral 9006

Ral 9016

• Tüm RAL seçenekleri / All colors available



Alüminyum enjeksiyon gövde
Alüminyum led soğutucu
Led driver
Yüksek saflıkta alüminyum reflektör
Dar, orta ve geniş açılı reflektör seçeneği
Elektrostatik toz boyalı

Die-cast aluminium body
Aluminium heatsink
Led driver
High purity aluminium reflector
Narrow, Medium and Wide angle reflectors
Electrostatic coating

CE IP20

Ral 9005

Ral 9006

Ral 9016

• Tüm RAL seçenekleri / All colors available



CODE : **SA 10.330**

COB LED modül

10W / 1200 lm.

2700K, 3000K, 4000K

Teknik Çizim / Technical drawing

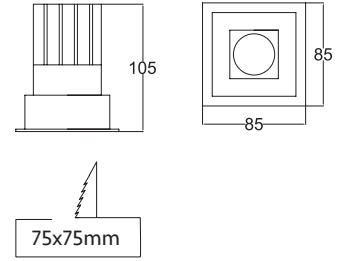

CODE : **SA 10.332**

COB LED modül

3x10W / 3600 lm.

2700K, 3000K, 4000K

Teknik Çizim / Technical drawing

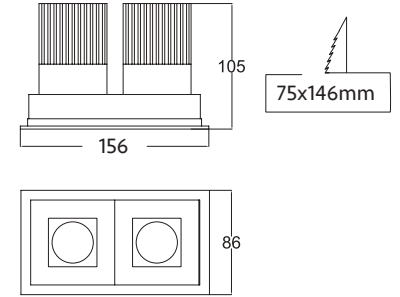

CODE : **SA 10.333**

COB LED modül

3x10W / 3600 lm.

2700K, 3000K, 4000K

Teknik Çizim / Technical drawing

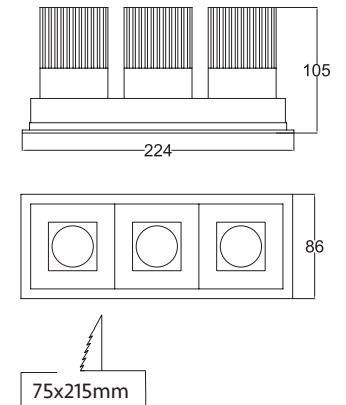

Alüminyum enjeksiyon gövde
Alüminyum led soğutucu
Led driver
Yüksek saflıkta alüminyum reflektör
Dar, orta ve geniş açılı reflektör seçeneği
Elektrostatik toz boyalı

Die-cast aluminium body
Aluminium heatsink
Led driver
High purity aluminium reflector
Narrow, Medium and Wide angle reflectors
Electrostatic coating

CE IP20

Ral 9005

Ral 9006

Ral 9016

• Tüm RAL seçenekleri / All colors available



CODE : **11.601**

Power LED

2W / 240 lm.

2700K, 3000K, 4000K

Teknik Çizim / Technical drawing

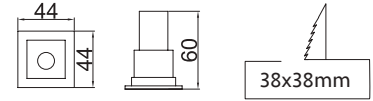

CODE : **11.602**

Power LED

2x2W / 480 lm.

2700K, 3000K, 4000K

Teknik Çizim / Technical drawing

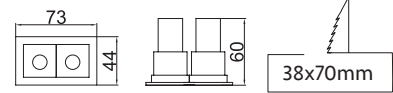

CODE : **11.603**

Power LED

3x2W / 720 lm.

2700K, 3000K, 4000K

Teknik Çizim / Technical drawing

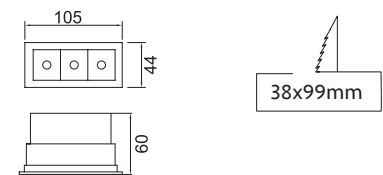

Alüminyum enjeksiyon gövde
Alüminyum led soğutucu
Led driver
Yüksek saflıkta alüminyum reflektör
Dar, orta ve geniş açılı reflektör seçeneği
Elektrostatik toz boyalı

Die-cast aluminium body
Aluminium heatsink
Led driver
High purity aluminium reflector
Narrow, Medium and Wide angle reflectors
Electrostatic coating



Ral 9005 Ral 9006 Ral 9016

• Tüm RAL seçenekleri / All colors available



CODE : **11.604**

Power LED

4x2W / 960 lm.

2700K, 3000K, 4000K

Teknik Çizim / Technical drawing

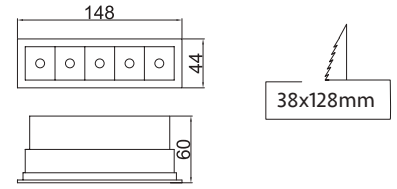

CODE : **11.605**

Power LED

5x2W / 1200 lm.

2700K, 3000K, 4000K

Teknik Çizim / Technical drawing

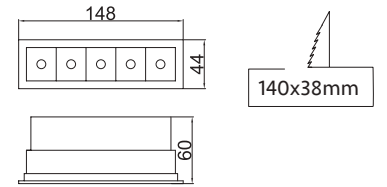

CODE : **11.609**

Power LED

9x2W / 2160 lm.

2700K, 3000K, 4000K

Teknik Çizim / Technical drawing

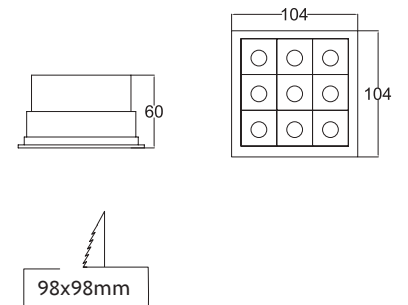



CODE : **SA 11.081**

Power LED

6x1W / 858 lm.

2700K, 3000K, 4000K

Teknik Çizim / Technical drawing

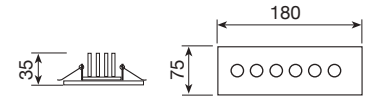

Paslanmaz gövde
Alüminyum led soğutucu
Led driver

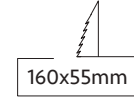

Stainless steel body
Aluminium heatsink
Led driver



CE IP20

Ral 9005

Ral 9006

Ral 9016

• Tüm RAL seçenekleri / All colors available

CODE : **SA 11.082**

Power LED

9x1W 1287 lm.

2700K, 3000K, 4000K

Teknik Çizim / Technical drawing

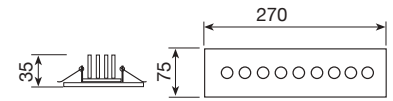

Paslanmaz gövde
Alüminyum led soğutucu
Led driver

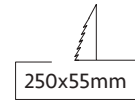

Stainless steel body
Aluminium heatsink
Led driver



CE IP20

Ral 9005

Ral 9006

Ral 9016

• Tüm RAL seçenekleri / All colors available



CODE : **10.014.L**

GU10 LED

5.5W 370 lm.

2700K, 3000K, 4000K

DKP gövde

Dar, orta ve geniş açılı reflektör seçeneği

Elektrostatik toz boyalı

20° yönlendirilebilir ampul

DKP steel body

Narrow, Medium and Wide angle reflectors

Electrostatic coating

20° adjustable bulbs

Teknik Çizim / Technical drawing

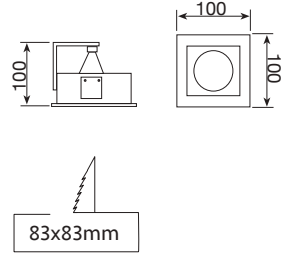

   IP20

Ral 9005

Ral 9006

Ral 9016

• Tüm RAL seçenekleri / All colors available





CODE : **10.162**

SMD LED

40W / 4800 lm.

2700K, 3000K, 4000K

Teknik Çizim / Technical drawing

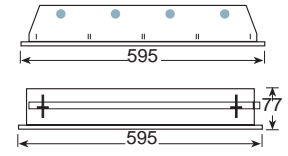

DKP gövde
UV koruyuculu akrilik prizmatik
Elektrostatik toz boyalı

DKP steel body
Acrylic prismatic with UV protection
Electrostatic coating

CE IP20

Ral 9005

Ral 9006

Ral 9016

• Tüm RAL seçenekleri / All colors available





SIVA ÜSTÜ ÜRÜNLER Surface Mounted Products



CODE : **40.160**

SMD LED modül

65W / 7345 lm.

2700K, 3000K, 4000K

Teknik Çizim / Technical drawing

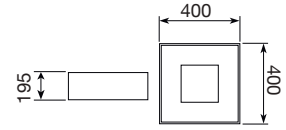

CODE : **40.161**

SMD LED modül

65W / 7345 lm.

2700K, 3000K, 4000K

Teknik Çizim / Technical drawing

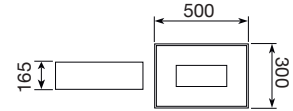

   IP20

Ral 9005

Ral 9006

Ral 9016

• Tüm RAL seçenekleri / All colors available

Alüminyum gövde

Led driver

Işık geçirgenliği yüksek opal pleksi

Elektrostatik toz boyalı

Opsiyonel Dali (isteğe bağlı)

Aluminium body

Led driver

Opal PMMA difuser.

Electrostatic coating

Optional Dali dim options

CODE : **40.162**

SMD LED modül

65W / 7345 lm.

2700K, 3000K, 4000K

Teknik Çizim / Technical drawing

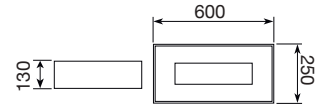



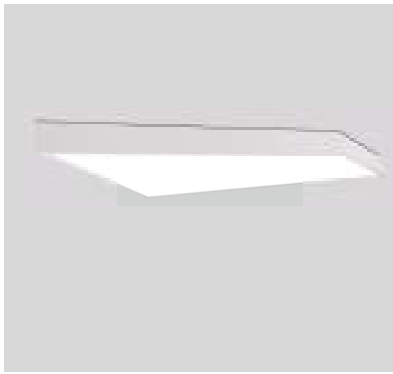
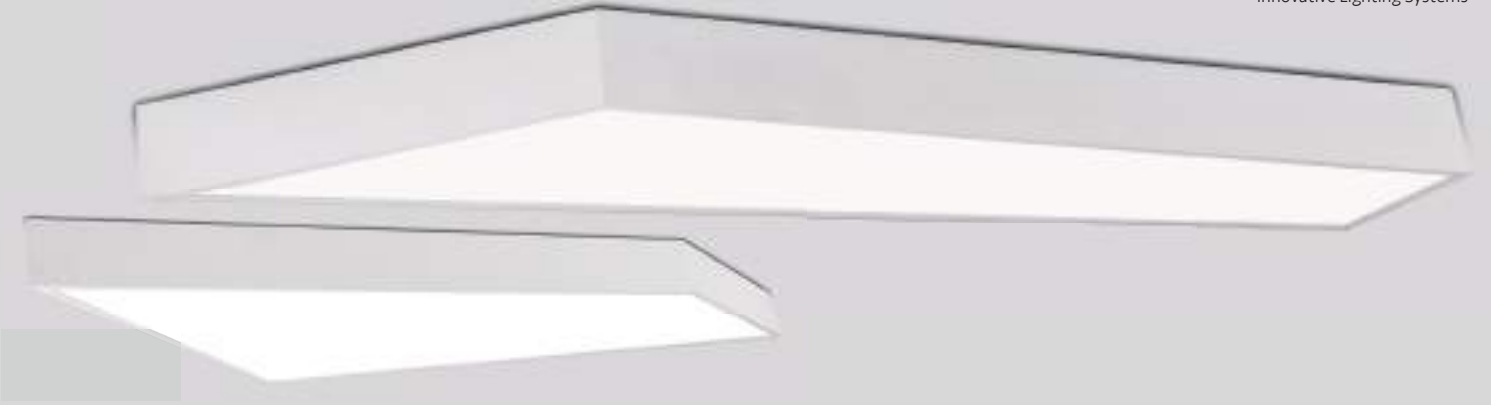

CODE : **40.130**

SMD LED modül

35W / 3955 lm.

2700K, 3000K, 4000K

Teknik Çizim / Technical drawing

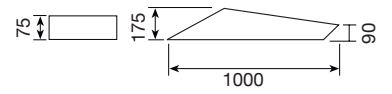

CODE : **40.131**

SMD LED modül

56W / 6328 lm.

2700K, 3000K, 4000K

Teknik Çizim / Technical drawing

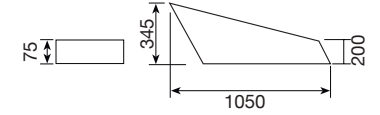

CE IP20

Ral 9005

Ral 9006

Ral 9016

• Tüm RAL seçenekleri / All colors available

Alüminyum gövde

Led driver

Işık geçirgenliği yüksek opal pleksi

Elektrostatik toz boyalı

Opsiyonel Dali (isteğe bağlı)

Aluminium body

Led driver

Opal PMMA difuser.

Electrostatic coating

Optional Dali dim options



Sarkıt uygulaması için çelik askı teli
Suspended application

CODE : **40.132**

SMD LED modül

70W / 7910 lm.

2700K, 3000K, 4000K

Teknik Çizim / Technical drawing

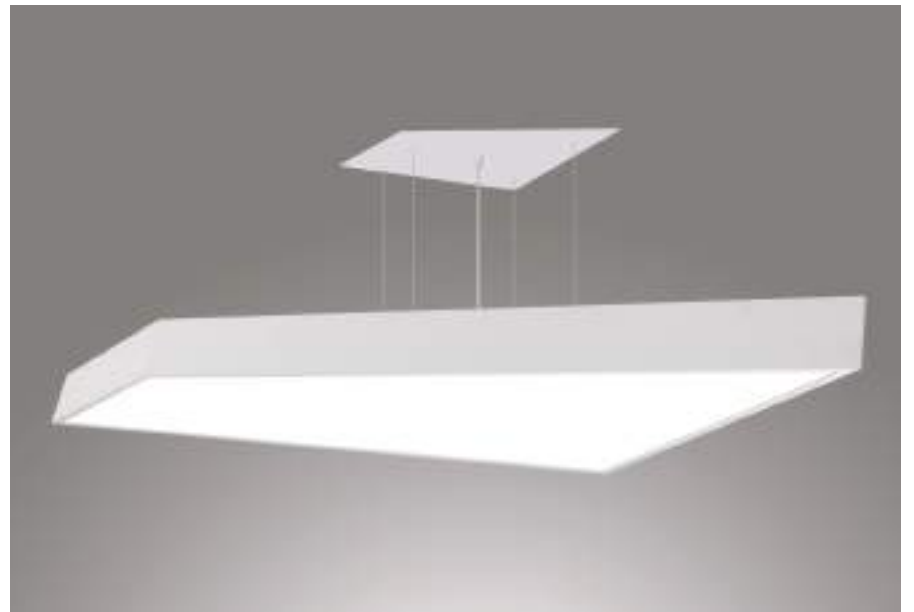
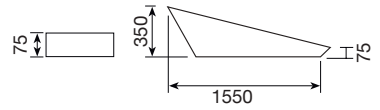



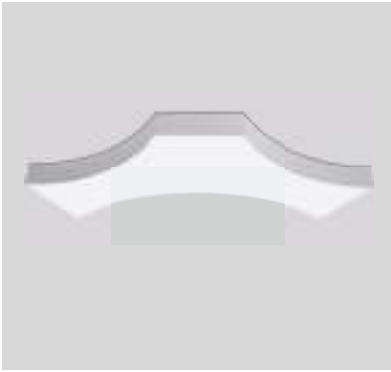
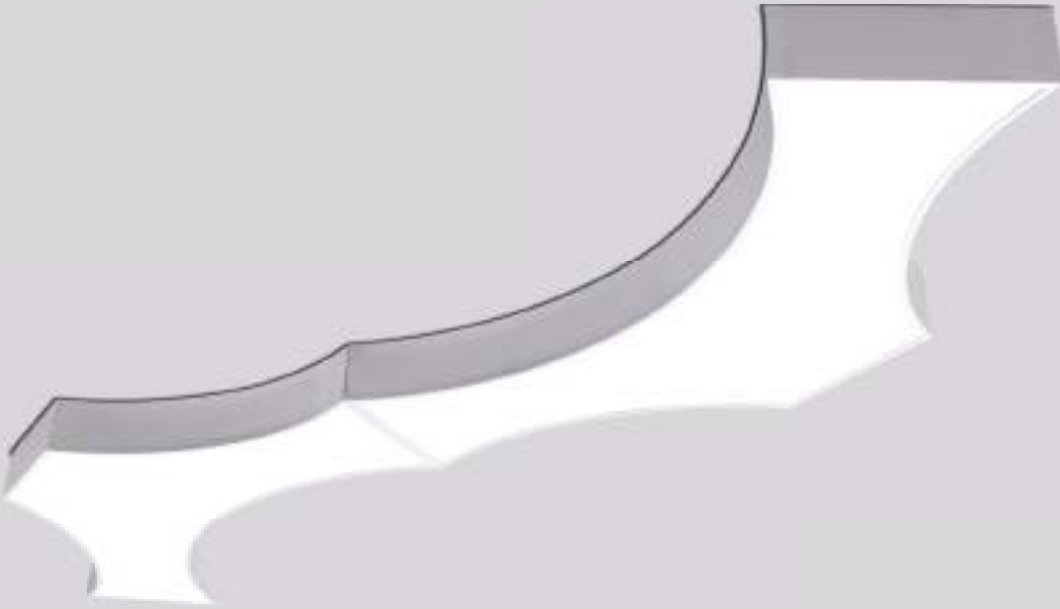

CE IP20

Ral 9005

Ral 9006

Ral 9016

• Tüm RAL seçenekleri / All colors available



Sarkıt uygulaması için çelik askı teli
Suspended application

CODE : **40.140**

SMD LED modül

30W / 3390 lm.

2700K, 3000K, 4000K

Alüminyum gövde

Led driver

Işık geçirgenliği yüksek opal pleksi

Elektrostatik toz boyalı

Opsiyonel Dali (isteğe bağlı)

Aluminium body

Led driver

Opal PMMA difuser.

Electrostatic coating

Optional Dali dim options

Teknik Çizim / Technical drawing

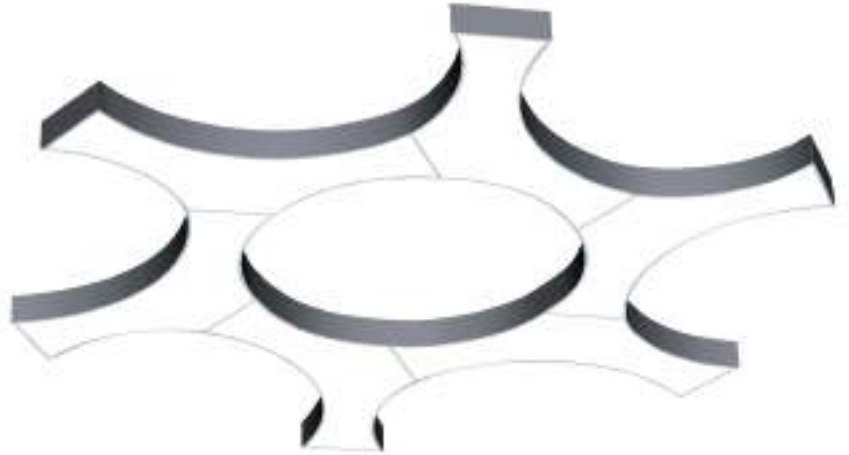
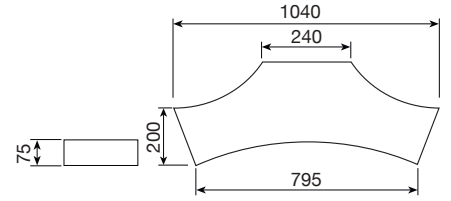





CE IP20

Ral 9005

Ral 9006

Ral 9016

• Tüm RAL seçenekleri / All colors available



Sarkıt uygulaması için çelik askı teli
Suspended application

CODE : **40.085**

SMD LED modül

30W / 3390 lm.

2700K, 3000K, 4000K

Alüminyum gövde

Led driver

Işık geçirgenliği yüksek opal pleksi

Elektrostatik toz boyalı

Opsiyonel Dali (isteğe bağlı)

Aluminium body

Led driver

Opal PMMA difuser.

Electrostatic coating

Optional Dali dim options

Teknik Çizim / Technical drawing

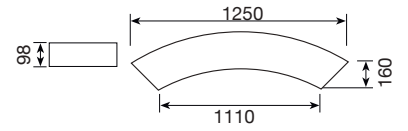



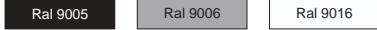

• Tüm RAL seçenekleri / All colors available

Alüminyum gövde
Led driver
Işık geçirgenliği yüksek opal pleksi
Elektrostatik toz boyalı
Opsiyonel Dali (isteğe bağlı)

Aluminium body
Led driver
Opal PMMA difuser.
Electrostatic coating
Optional Dali dim options



Sarkıt uygulaması için çelik askı teli
Suspended application

CODE : **40.040**

SMD LED modül
22W / 2486 lm.
2700K, 3000K, 4000K

Teknik Çizim / Technical drawing

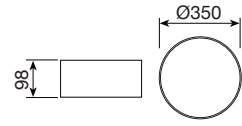

CODE : **40.041**

SMD LED modül
27W / 3051 lm.
2700K, 3000K, 4000K

Teknik Çizim / Technical drawing

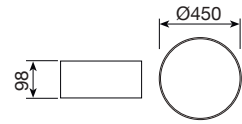

CODE : **40.042**

SMD LED modül
54W / 6102 lm.
2700K, 3000K, 4000K

Teknik Çizim / Technical drawing

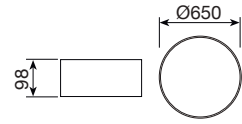

CODE : **40.043**

SMD LED modül
110W / 12430 lm.
2700K, 3000K, 4000K

Teknik Çizim / Technical drawing

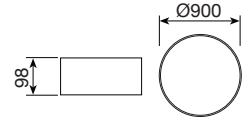

CODE : **40.044**

SMD LED modül
150W / 16950 lm.
2700K, 3000K, 4000K

Teknik Çizim / Technical drawing

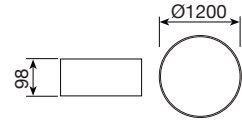

CODE : **40.045**

SMD LED modül
200W / 22600 lm.
2700K, 3000K, 4000K

Teknik Çizim / Technical drawing

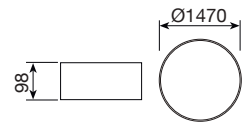





CE IP20

Ral 9005 Ral 9006 Ral 9016

• Tüm RAL seçenekleri / All colors available

Alüminyum gövde
Led driver
Işık geçirgenliği yüksek opal pleksi
Elektrostatik toz boyalı
Opsiyonel Dali (isteğe bağlı)

Aluminium body
Led driver
Opal PMMA difuser.
Electrostatic coating
Optional Dali dim options



Sarkıt uygulaması için çelik askı teli
Suspended application

CODE : **40.095**

SMD LED modül

56W / 6228 lm.

2700K, 3000K, 4000K

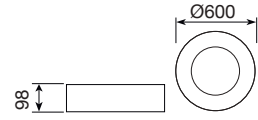

CODE : **40.096**

SMD LED modül

84W / 9492 lm.

2700K, 3000K, 4000K

Teknik Çizim / Technical drawing

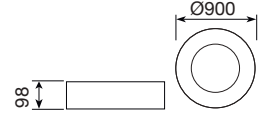

CODE : **40.097**

SMD LED modül

112W / 12256 lm.

2700K, 3000K, 4000K

Teknik Çizim / Technical drawing

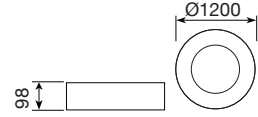

CODE : **40.098**

SMD LED modül

140W / 15820 lm.

2700K, 3000K, 4000K

Teknik Çizim / Technical drawing

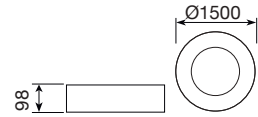

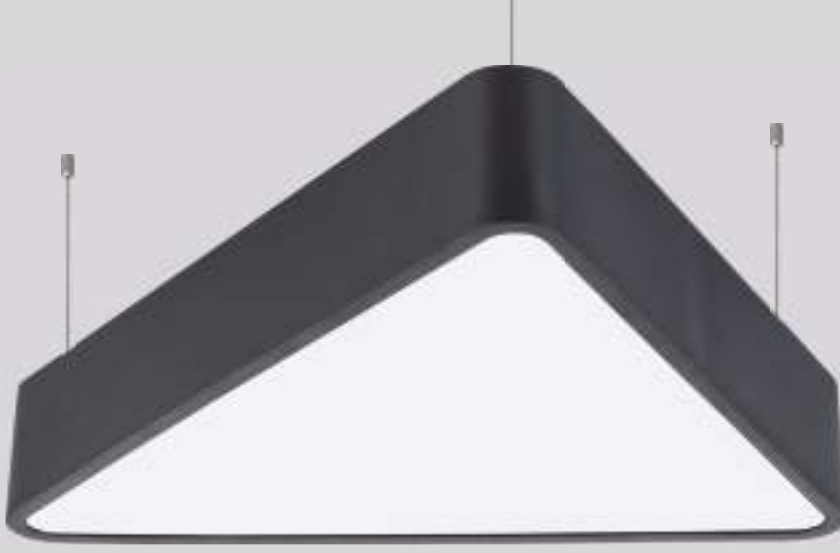

CODE : **50.170**

SMD LED modül

27W / 3051 lm.

2700K, 3000K, 4000K

Teknik Çizim / Technical drawing

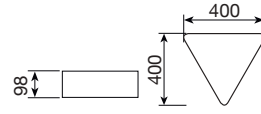

CODE : **50.171**

SMD LED modül

40W / 4520 lm.

2700K, 3000K, 4000K

Teknik Çizim / Technical drawing

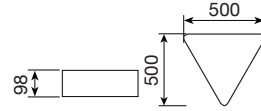

□ CE IP20

Ral 9005

Ral 9006

Ral 9016

• Tüm RAL seçenekleri / All colors available

Alüminyum gövde

Led driver

Işık geçirgenliği yüksek opal pleksi

Elektrostatik toz boyalı

Opsiyonel Dali (isteğe bağlı)

Aluminium body

Led driver

Opal PMMA difuser.

Electrostatic coating

Optional Dali dim options

CODE : **50.172**

SMD LED modül

53 / 5989 lm.

2700K, 3000K, 4000K

Teknik Çizim / Technical drawing

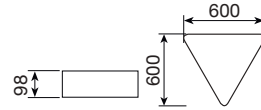

Sarkıt uygulaması için çelik askı teli
Suspended application

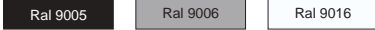
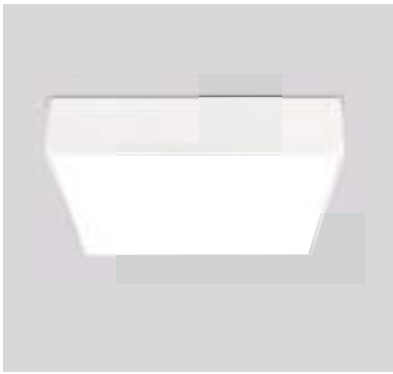

• Tüm RAL seçenekleri / All colors available

Alüminyum gövde
Led driver
Işık geçirgenliği yüksek opal pleksi
Elektrostatik toz boyalı
Opsiyonel Dali (isteğe bağlı)

Aluminium body
Led driver
Opal PMMA difuser.
Electrostatic coating
Optional Dali dim options



Sarkıt uygulaması için çelik askı teli
Suspended application

CODE : **40.070**

SMD LED modül

15W / 1695 lm.

2700K, 3000K, 4000K

Teknik Çizim / Technical drawing

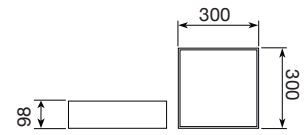

CODE : **40.071**

SMD LED modül

25W / 2825 lm.

2700K, 3000K, 4000K

Teknik Çizim / Technical drawing

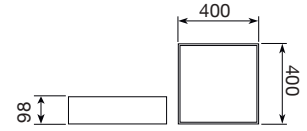

CODE : **40.072**

SMD LED modül

45W / 5085 lm.

2700K, 3000K, 4000K

Teknik Çizim / Technical drawing

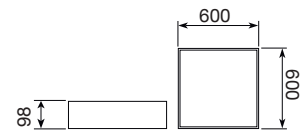

CODE : **40.073**

SMD LED modül

120W / 13560 lm.

2700K, 3000K, 4000K

Teknik Çizim / Technical drawing

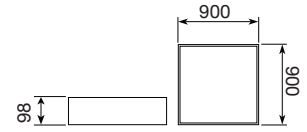

CODE : **40.074**

SMD LED modül

120W / 13560 lm.

2700K, 3000K, 4000K

Teknik Çizim / Technical drawing

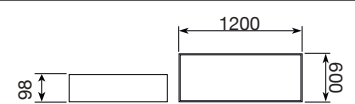



CODE : **40.100**

SMD LED modül

35W / 3955 lm.

2700K, 3000K, 4000K

Teknik Çizim / Technical drawing

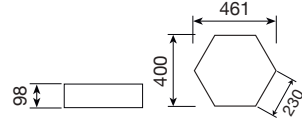

CODE : **40.101**

SMD LED modül

70W / 7910 lm.

2700K, 3000K, 4000K

Teknik Çizim / Technical drawing

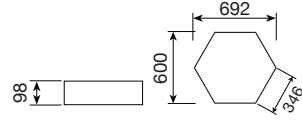

□ CE IP20

Ral 9005

Ral 9006

Ral 9016

• Tüm RAL seçenekleri / All colors available

Alüminyum gövde

Led driver

Işık geçirgenliği yüksek opal pleksi

Elektrostatik toz boyalı

Opsiyonel Dali (isteğe bağlı)

Aluminium body

Led driver

Opal PMMA difuser.

Electrostatic coating

Optional Dali dim options

CODE : **40.102**

SMD LED modül

110W / 12430 lm.

2700K, 3000K, 4000K

Teknik Çizim / Technical drawing

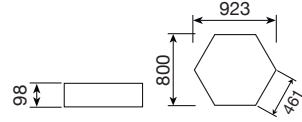

Sarkıt uygulaması için çelik askı teli
Suspended application



CE IP20

Ral 9005

Ral 9006

Ral 9016

• Tüm RAL seçenekleri / All colors available

Alüminyum gövde
Led driver
Işık geçirgenliği yüksek opal pleksi
Elektrostatik toz boyalı
Opsiyonel DALI (isteğe bağlı)

Aluminium body
Led driver
Opal PMMA difuser.
Electrostatic coating
Optional DALI dim options



Sarkıt uygulaması için çelik askı teli
Suspended application

CODE : **40.110**
SMD LED modül
25W / 2825 lm.
2700K, 3000K, 4000K

Teknik Çizim / Technical drawing

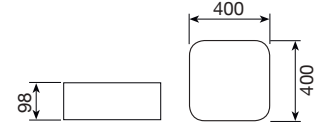

CODE : **40.111**
SMD LED modül
45W / 5085 lm.
2700K, 3000K, 4000K

Teknik Çizim / Technical drawing

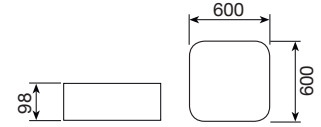

CODE : **40.112**
SMD LED modül
120W / 13560 lm.
2700K, 3000K, 4000K

Teknik Çizim / Technical drawing

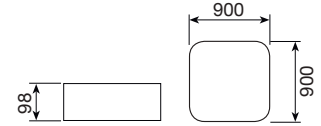

CODE : **40.113**
SMD LED modül
120W / 13560 lm.
2700K, 3000K, 4000K

Teknik Çizim / Technical drawing

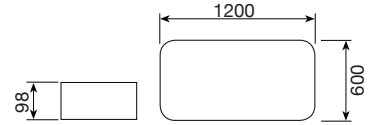

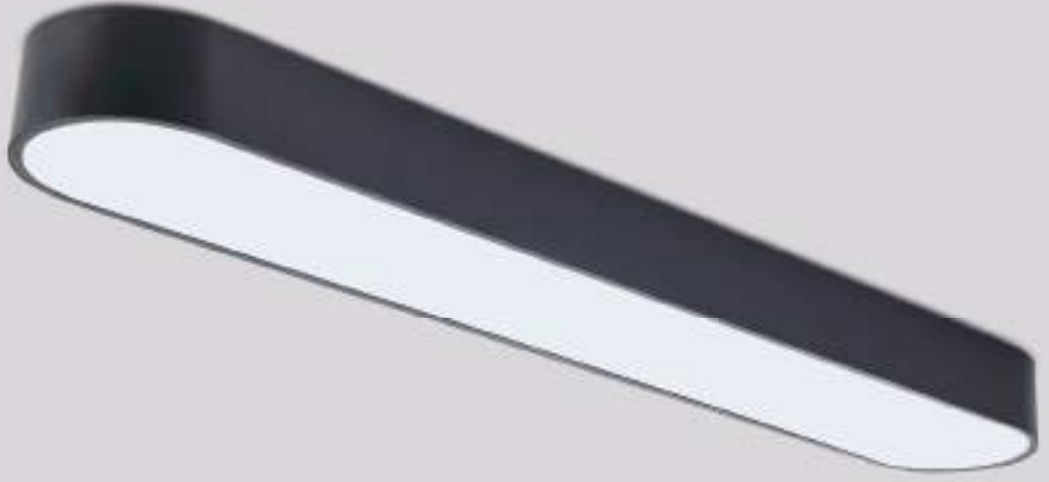

CODE : **40.120**

SMD LED modül

22W / 2486 lm.

2700K, 3000K, 4000K

Teknik Çizim / Technical drawing

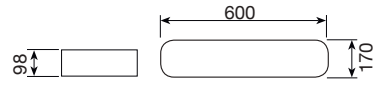

CODE : **40.121**

SMD LED modül

35W / 3955 lm.

2700K, 3000K, 4000K

Teknik Çizim / Technical drawing

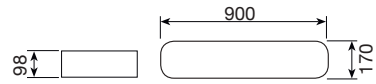

□ CE IP20

Ral 9005

Ral 9006

Ral 9016

• Tüm RAL seçenekleri / All colors available

CODE : **40.122**

SMD LED modül

50W / 5650 lm.

2700K, 3000K, 4000K

Teknik Çizim / Technical drawing

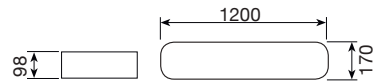

Alüminyum gövde

Led driver

Işık geçirgenliği yüksek opal pleksi

Elektrostatik toz boyalı

Opsiyonel Dali (isteğe bağlı)

Aluminium body

Led driver

Opal PMMA difuser.

Electrostatic coating

Optional Dali dim options



Sarkıt uygulaması için çelik askı teli
Suspended application



CE IP20

Ral 9005 Ral 9006 Ral 9016

• Tüm RAL seçenekleri / All colors available

Alüminyum gövde
Led driver
Işık geçirgenliği yüksek opal pleksi
Elektrostatik toz boyalı
Opsiyonel Dali (isteğe bağlı)

Aluminium body
Led driver
Opal PMMA difuser.
Electrostatic coating
Optional Dali dim options



Sarkıt uygulaması için çelik askı teli
Suspended application

CODE : **50.055**

SMD LED modül

54W / 6102 lm.

2700K, 3000K, 4000K

Teknik Çizim / Technical drawing

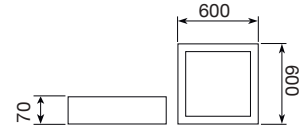

CODE : **50.056**

SMD LED modül

96W / 10848 lm.

2700K, 3000K, 4000K

Teknik Çizim / Technical drawing

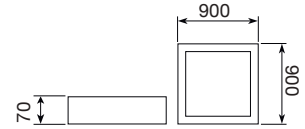

CODE : **50.057**

SMD LED modül

96W / 10848 lm.

2700K, 3000K, 4000K

Teknik Çizim / Technical drawing

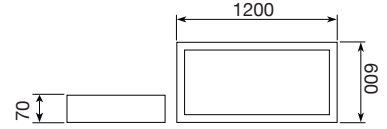



CODE : **50.065**

SMD LED modül

48W / 5424 lm.

2700K, 3000K, 4000K

Teknik Çizim / Technical drawing

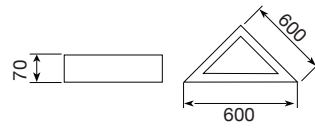

CODE : **50.066**

SMD LED modül

72W / 8136 lm.

2700K, 3000K, 4000K

Teknik Çizim / Technical drawing

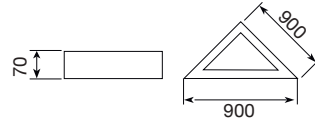

□ CE IP20

Ral 9005

Ral 9006

Ral 9016

• Tüm RAL seçenekleri / All colors available

Alüminyum gövde

Led driver

Işık geçirgenliği yüksek opal pleksi

Elektrostatik toz boyalı

Opsiyonel Dali (isteğe bağlı)

Aluminium body

Led driver

Opal PMMA difuser.

Electrostatic coating

Optional Dali dim options



Sarkıt uygulaması için çelik askı teli
Suspended application



CODE : **40.063**

Power LED

6x2W / 1400 lm.

2700K, 3000K, 4000K

Teknik Çizim / Technical drawing

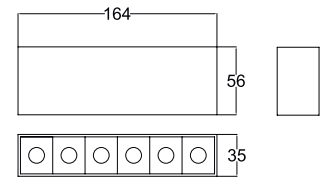

CODE : **40.064**

Power LED

10x2W / 2000 lm.

2700K, 3000K, 4000K

Teknik Çizim / Technical drawing

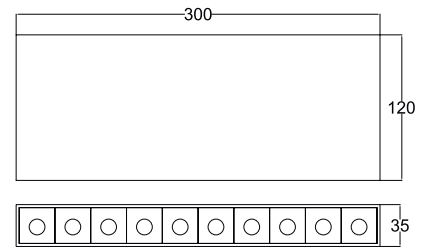

CE IP20

Ral 9005

Ral 9006

Ral 9016

• Tüm RAL seçenekleri / All colors available

Alüminyum gövde
Led driver
Elektrostatik toz boyalı
Opsiyonel Dali (isteğe bağlı)

Aluminium body
Led driver
Electrostatic coating
Optional Dali dim options

Alüminyum gövde
Led driver
Elektrostatik toz boyalı
Opsiyonel Dalı (isteğe bağlı)

Aluminium body
Led driver
Electrostatic coating
Optional Dali dim options

□ CE IP20

Ral 9005

Ral 9006

Ral 9016

• Tüm RAL seçenekleri / All colors available



CODE : **40.065**

Power LED

9x2W / 1800 lm.

2700K, 3000K, 4000K

Teknik Çizim / Technical drawing

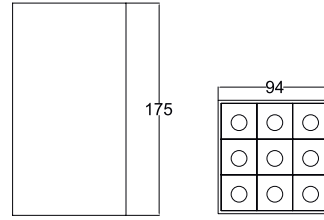

CODE : **40.066**

Power LED

8W / 960 lm.

2700K, 3000K, 4000K

Teknik Çizim / Technical drawing

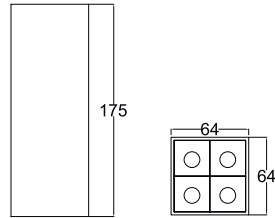

CODE : **40.067**

Power LED

2W / 200 lm.

2700K, 3000K, 4000K

Teknik Çizim / Technical drawing



Alüminyum enjeksiyon gövde
Alüminyum led soğutucu
Led driver
Isıya dayanıklı cam
Yüksek saflıkta alüminyum reflektör
Dar, orta ve geniş açılı reflektör seçeneği
Elektrostatik toz boyalı

Die-cast aluminium body
Aluminium heatsink
Led driver
Tempered glass
High purity aluminium reflector
Narrow, Medium and Wide angle reflectors
Electrostatic coating



CODE : **40.431**

SMD LED modül

10W / 1200 lm.

2700K, 3000K, 4000K

Teknik Çizim / Technical drawing

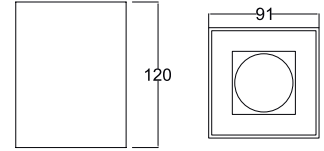

   IP20

Ral 9005

Ral 9006

Ral 9016

• Tüm RAL seçenekleri / All colors available



CODE : **40.432**

SMD LED modül

2x10W / 2400 lm.

2700K, 3000K, 4000K

Teknik Çizim / Technical drawing

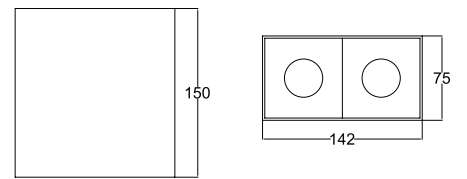

   IP20

Ral 9005

Ral 9006

Ral 9016

• Tüm RAL seçenekleri / All colors available



Alüminyum enjeksiyon gövde
Alüminyum led soğutucu
Led driver
Isıya dayanıklı cam
Yüksek saflıkta alüminyum reflektör
Dar, orta ve geniş açılı reflektör seçeneği
Elektrostatik toz boyalı

Die-cast aluminium body
Aluminium heatsink
Led driver
Tempered glass
High purity aluminium reflector
Narrow, Medium and Wide angle reflectors
Electrostatic coating



Ral 9005

Ral 9006

Ral 9016

• Tüm RAL seçenekleri / All colors available



CODE : **40.201**

COB LED

12W / 1500 lm.

2700K, 3000K, 4000K

Teknik Çizim / Technical drawing

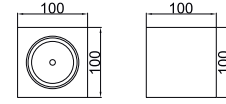

CODE : **40.202**

COB LED

24W / 3000 lm.

2700K, 3000K, 4000K

Teknik Çizim / Technical drawing

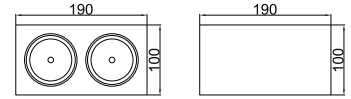

CODE : **40.203**

COB LED

36W / 4500 lm.

2700K, 3000K, 4000K

Teknik Çizim / Technical drawing

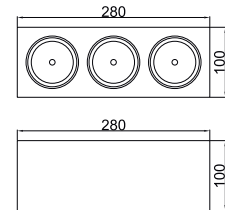

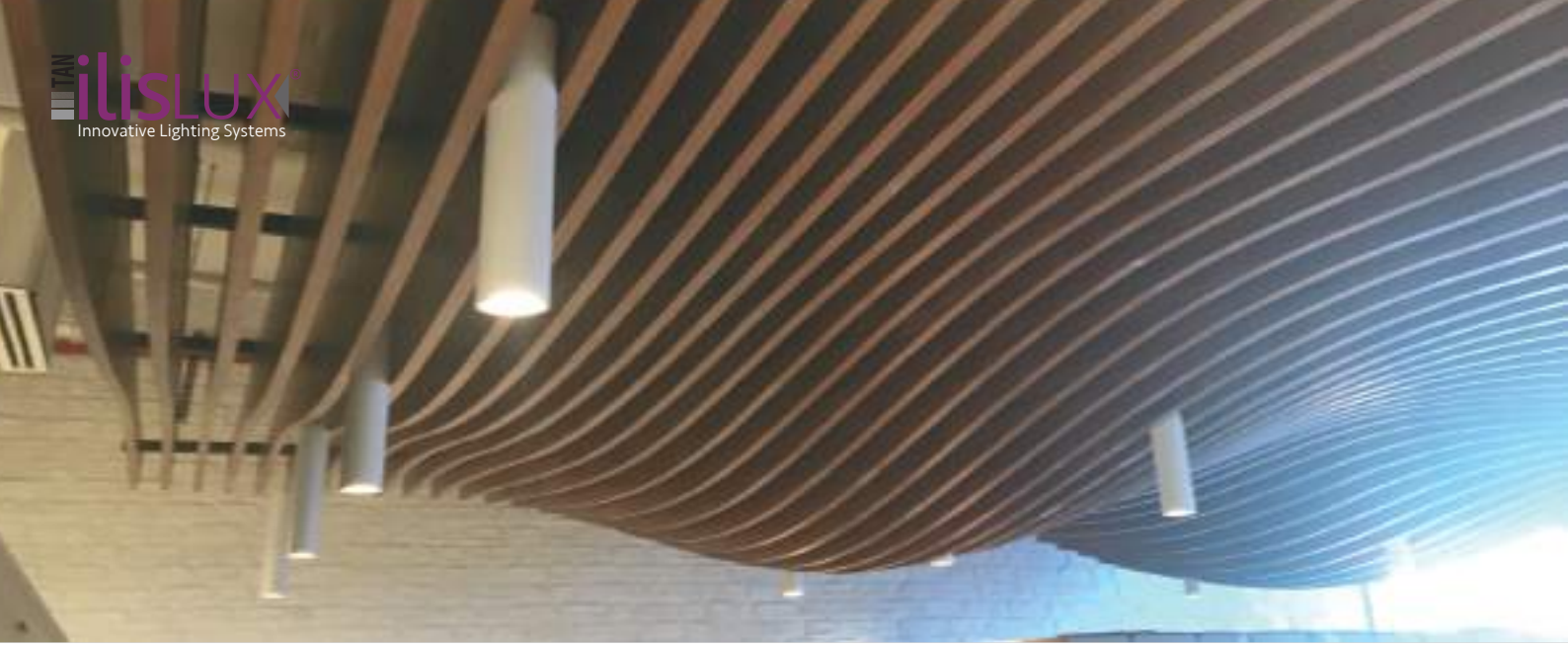

CODE : **40.036**

SMD LED modül

8W / 1000 lm.

2700K, 3000K, 4000K

Teknik Çizim / Technical drawing

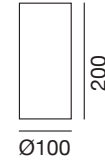

CODE : **40.037**

SMD LED modül

15W / 1800 lm.

2700K, 3000K, 4000K

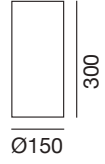

CE IP20

Ral 9005

Ral 9006

Ral 9016

• Tüm RAL seçenekleri / All colors available



Sarkıt uygulaması için çelik askı teli
Suspended application

Alüminyum enjeksiyon gövde

Alüminyum led soğutucu

Led driver

Isıya dayanıklı cam

Yüksek safılıkta alüminyum reflektör

Dar, orta ve geniş açılı reflektör seçeneği

Elektrostatik toz boyalı

Die-cast aluminium body

Aluminium heatsink

Led driver

Tempered glass

High purity aluminium reflector

Narrow, Medium and Wide angle reflectors

Electrostatic coating



Alüminyum enjeksiyon gövde
Alüminyum led soğutucu
Led driver
Isiya dayanıklı cam
Yüksek saflıkta alüminyum reflektör
Dar, orta ve geniş açılı reflektör seçeneği
Elektrostatik toz boyalı

Die-cast aluminium body
Aluminium heatsink
Led driver
Tempered glass
High purity aluminium reflector
Narrow, Medium and Wide angle reflectors
Electrostatic coating



CODE : **40.651**

SMD LED modül

8W / 1000 lm.

2700K, 3000K, 4000K

Teknik Çizim / Technical drawing

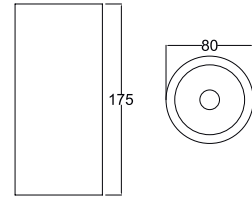

□ CE IP44

Ral 9005

Ral 9006

Ral 9016

• Tüm RAL seçenekleri / All colors available

CODE : **40.450**

SMD LED modül

12W / 1500 lm.

2700K, 3000K, 4000K

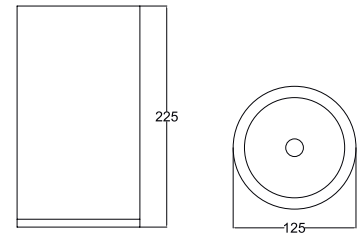

CODE : **40.650**

SMD LED modül

8W / 1000 lm.

2700K, 3000K, 4000K

Teknik Çizim / Technical drawing

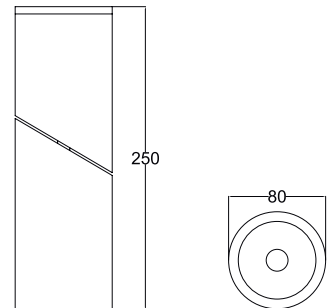

□ CE IP44

Ral 9005

Ral 9006

Ral 9016

• Tüm RAL seçenekleri / All colors available

Alüminyum enjeksiyon gövde
Elektrostatik toz boyalı

Die-cast aluminium body
Electrostatic coating

CE IP20

Ral 9005

Ral 9006

Ral 9016

• Tüm RAL seçenekleri / All colors available



CODE : **40.221**

GU10 LED

5.5W / 370 lm.

2700K, 3000K, 4000K

Teknik Çizim / Technical drawing

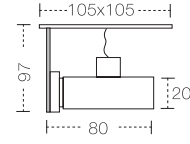

CODE : **40.222**

GU10 LED

2x5.5W / 2x370 lm.

2700K, 3000K, 4000K

Teknik Çizim / Technical drawing

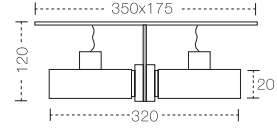

CODE : **40.223**

GU10 LED

3x5.5W / 3x370 lm.

2700K, 3000K, 4000K

Teknik Çizim / Technical drawing

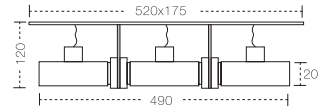

Alüminyum enjeksiyon gövde
Alüminyum led soğutucu
Led driver
Isıya dayanıklı cam
Yüksek saflıkta alüminyum reflektör
Dar, orta ve geniş açılı reflektör seçeneği
Elektrostatik toz boyalı

Die-cast aluminium body
Aluminium heatsink
Led driver
Tempered glass
High purity aluminium reflector
Narrow, Medium and Wide angle reflectors
Electrostatic coating

□ CE  IP20

Ral 9005

Ral 9006

Ral 9016

• Tüm RAL seçenekleri / All colors available

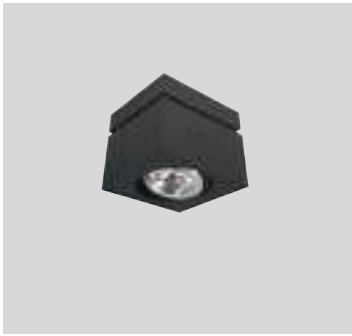

CODE : **40.010**

COB LED

12W / 1500 lm.

2700K, 3000K, 4000K

Teknik Çizim / Technical drawing

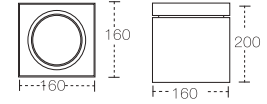

CODE : **40.011**

COB LED

24W / 3000 lm.

2700K, 3000K, 4000K

Teknik Çizim / Technical drawing

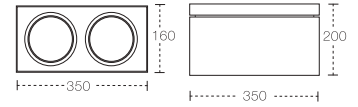

CODE : **40.012**

COB LED

36W / 4500 lm.

2700K, 3000K, 4000K

Teknik Çizim / Technical drawing

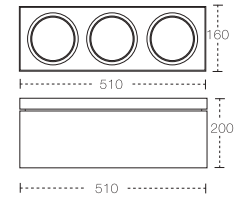

CODE : **40.013**

COB LED

48W / 6000 lm.

2700K, 3000K, 4000K

Teknik Çizim / Technical drawing

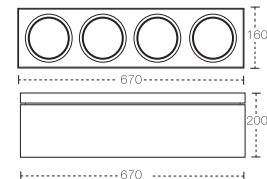



CODE : **10.162**

SMD LED

40W / 4800 lm.

2700K, 3000K, 4000K

Teknik Çizim / Technical drawing

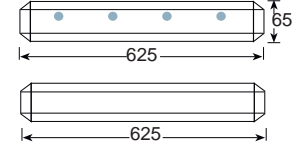

DKP gövde
UV koruyuculu akrilik prizmatik
Elektrostatik toz boyalı

DKP steel body
Acrylic prismatic with UV protection
Electrostatic coating

   IP20

Ral 9005

Ral 9006

Ral 9016

• Tüm RAL seçenekleri / All colors available



SARKIT ÜRÜNLER pendant products







CE IP20

Ral 9005 Ral 9006 Ral 9016

• Tüm RAL seçenekleri / All colors available

Alüminyum profil

Led driver

Yuvarlak 6 metre kesintisiz polikarbon ışıklık

Yükseklik ayarı yapılabilen çelik askı teli

Elektrostatik toz boyalı

Aluminium profile

Led driver

Round 6 meters in seamless polycarbonaet skylight

Steel wire for installation, which enables the

variation of the height of the luminary

Electrostatic coating



Sarkıt uygulaması için çelik askı teli
Suspended application

CODE : **50.050.57**

SMD LED Module

13W / 1430 lm.

2700K, 3000K, 4000K

Teknik Çizim / Technical drawing

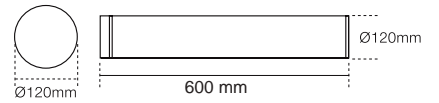

CODE : **50.050.85**

SMD LED Module

19W / 2090 lm.

2700K, 3000K, 4000K

Teknik Çizim / Technical drawing

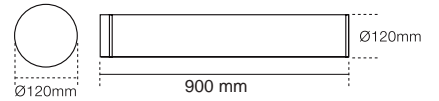

CODE : **50.050.113**

SMD LED Module

26W / 2860 lm.

2700K, 3000K, 4000K

Teknik Çizim / Technical drawing

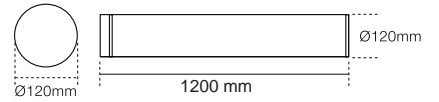

CODE : **50.050.141**

SMD LED Module

32W / 3520 lm.

2700K, 3000K, 4000K

Teknik Çizim / Technical drawing

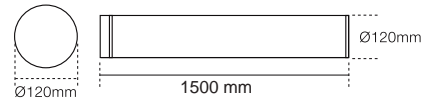



CODE : **50.110**

SMD LED Module

56W / 6328 lm.

2700K, 3000K, 4000K

Teknik Çizim / Technical drawing

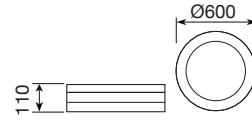

CODE : **50.111**

SMD LED Module

80W / 9040 lm.

2700K, 3000K, 4000K

Teknik Çizim / Technical drawing

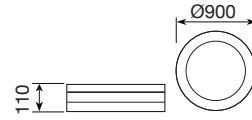

□ CE IP20

Ral 9005

Ral 9006

Ral 9016

• Tüm RAL seçenekleri / All colors available

Alüminyum profil gövde

Led driver

Yüksek geçirgenlikli opal pleksi

Yükseklik ayarı yapılabilen çelik askı teli

Elektrostatik toz boyalı

Aluminium profile body

Led driver

Opal PMMA diffuser

Steel wire for installation, which enables the variation of the height of the luminary

Electrostatic coating



Sarkıt uygulaması için çelik askı teli
Suspended application



CODE : **50.004**

SMD LED Module

36W / 4800 lm.

2700K, 3000K, 4000K

Teknik Çizim / Technical drawing

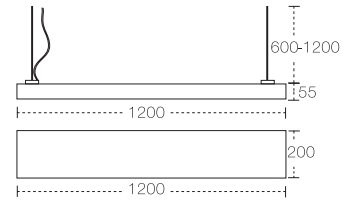

Alüminyum gövde
Led driver
Yüksek geçirgenlikli opal pleksi
Yükseklik ayarı yapılabilen çelik askı teli
Elektrostatik toz boyalı

Aluminium body
Led driver
Opal PMMA diffuser
Steel wire for installation, which enables
the variation of the height of the luminaire
Electrostatic coating

CE IP20

Ral 9005

Ral 9006

Ral 9016

• Tüm RAL seçenekleri / All colors available



Sarkıt uygulaması için çelik askı teli
Suspended application

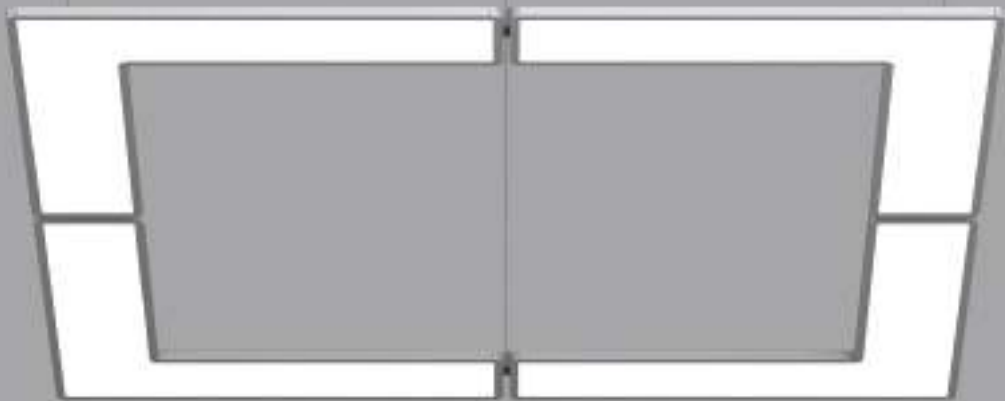



CE IP20

Ral 9005

Ral 9006

Ral 9016

• Tüm RAL seçenekleri / All colors available

CODE : **50.300**

SMD Led Modul

40W / 4800 lm.

2700K, 3000K, 4000K

Alüminyum gövde
Led driver
Özel taramalı şeffaf pleksi
Yükseklik ayarı yapılabilen çelik askı teli
Elektrostatik toz boyalı

Aluminium body
Led driver
Transparent plexi with special scanning
Steel wire for installation, which enables
the variation of the height of the luminary
Electrostatic coating

Teknik Çizim / Technical drawing

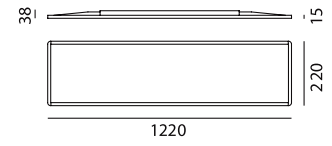

CE IP20

Ral 9005

Ral 9006

Ral 9016

• Tüm RAL seçenekleri / All colors available

CODE : **50.301**

SMD Led Modul

20W / 2400 lm.

2700K, 3000K, 4000K

Alüminyum gövde
Led driver
Özel taramalı şeffaf pleksi
Yükseklik ayarı yapılabilen çelik askı teli
Elektrostatik toz boyalı

Aluminium body
Led driver
Transparent plexi with special scanning
Steel wire for installation, which enables
the variation of the height of the luminary
Electrostatic coating

Teknik Çizim / Technical drawing

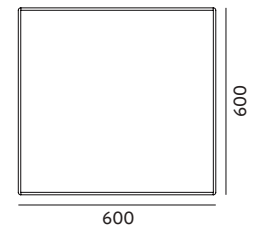

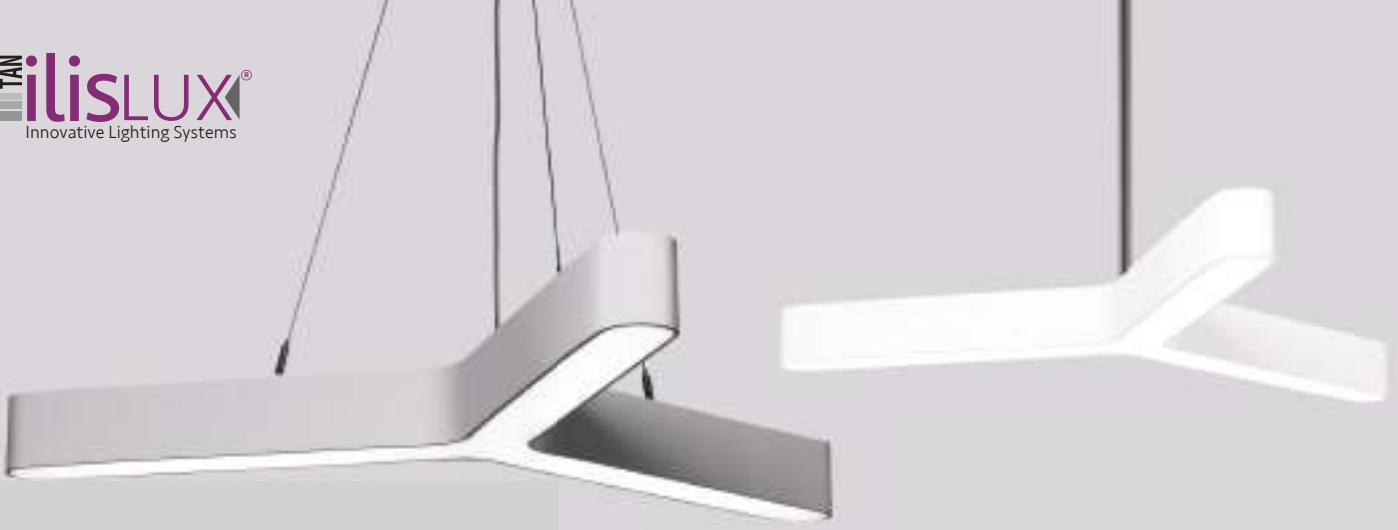

CODE : **50.060**

SMD LED Module

54W / 4000 lm.

2700K, 3000K, 4000K

Teknik Çizim / Technical drawing



   IP20

Ral 9005

Ral 9006

Ral 9016

• Tüm RAL seçenekleri / All colors available

Alüminyum gövde

Led driver

Yüksek geçirgenlikli opal pleksi

Yükseklik ayarı yapılabilen çelik askı teli

Elektrostatik toz boyalı

Aluminium body

Led driver

Opal PMMA diffuser

Steel wire for installation, which enables the

variation of the height of the luminary

Electrostatic coating



Sarkıt uygulaması için çelik askı teli
Suspended application



CE IP20

Ral 9005

Ral 9006

Ral 9016

• Tüm RAL seçenekleri / All colors available

CODE : **50.200**

SMD Led Modul

50W / 4000 lm.

2700K, 3000K, 4000K

Teknik Çizim / Technical drawing

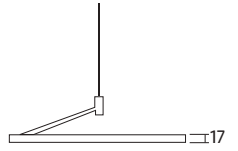
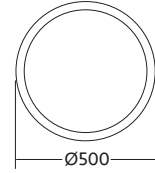

Alüminyum gövde
Led driver
Özel taramalı şeffaf pleksi
Yükseklik ayarı yapılabilen çelik askı teli
Elektrostatik toz boyalı

Aluminium body
Led driver
Transparent plexi with special scanning
Steel wire for installation, which enables
the variation of the height of the luminaire
Electrostatic coating





CE IP20

Ral 9005

Ral 9006

Ral 9016

• Tüm RAL seçenekleri / All colors available

CODE : **50.047**

SMD LED Module

35W / 4200 lm.

2700K, 3000K, 4000K

DKP & Alüminyum gövde
Led driver
Yüksek geçirgenlikli opal pleksi
Yükseklik ayarı yapılabilen çelik askı teli
Elektrostatik toz boyalı

DKP & Aluminium body
Led driver
Opal PMMA diffuser
Steel wire for installation, which enables the
variation of the height of the luminary
Electrostatic coating

Teknik Çizim / Technical drawing

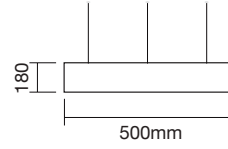

CE IP20

Ral 9005

Ral 9006

Ral 9016

• Tüm RAL seçenekleri / All colors available

CODE : **50.048**

SMD LED Module

35W / 4200 lm.

2700K, 3000K, 4000K

DKP & Alüminyum gövde
Led driver
Yüksek geçirgenlikli opal pleksi
Yükseklik ayarı yapılabilen çelik askı teli
Elektrostatik toz boyalı

DKP & Aluminium body
Led driver
Opal PMMA diffuser
Steel wire for installation, which enables the
variation of the height of the luminary
Electrostatic coating

Teknik Çizim / Technical drawing

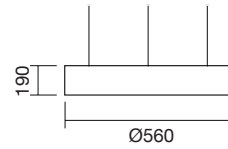



CODE : **50.049**

E27 Lamp

18-23W E27 Dulux Star

28-42W E27 Halogen ECO

Teknik Çizim / Technical drawing

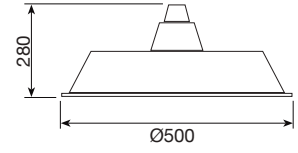

Alüminyum gövde
Elektrostatik toz boyalı

Aluminium body
Electrostatic coating

   IP20

Ral 9005

Ral 9006

Ral 9016

• Tüm RAL seçenekleri / All colors available



Sarkıt uygulaması için çelik askı teli
Suspended application



CODE : **60.300**

Teknik Çizim / Technical drawing

LED

5W / 600 lm.

2700K, 3000K, 4000K

Ahşap gövde
Led driver
Şeffaf akrilik

Wooden body
Led driver
Clear acrylic

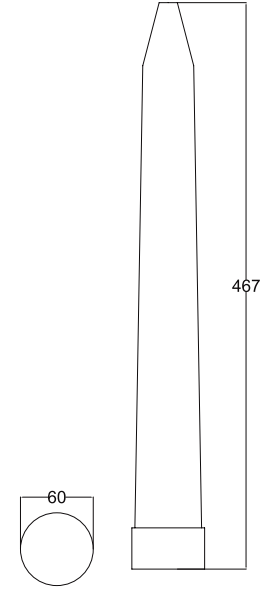

□ CE IP40

Ral 9005

Ral 9006

Ral 9016

• Tüm RAL seçenekleri / All colors available

CODE : **60.301**

Teknik Çizim / Technical drawing

LED

3W / 300 lm.

2700K, 3000K, 4000K

Ahşap gövde
Led driver
Şeffaf akrilik

Wooden body
Led driver
Clear acrylic

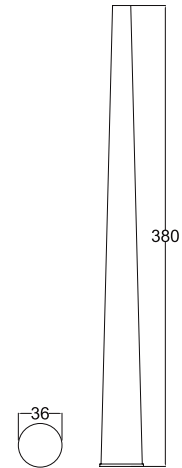

□ CE IP40

Ral 9005

Ral 9006

Ral 9016

• Tüm RAL seçenekleri / All colors available



CODE : **50.210**

SMD LED
40W / 4800 lm
2700K, 3000K, 4000K



Teknik Çizim / Technical drawing

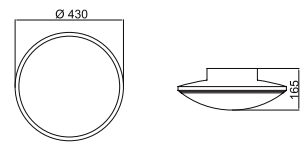

CODE : **50.211**

SMD LED
60W / 7200 lm
2700K, 3000K, 4000K



Teknik Çizim / Technical drawing

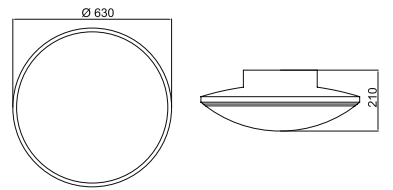

□ CE IP40

Ral 9005

Ral 9006

Ral 9016

• Tüm RAL seçenekleri / All colors available

Alüminyum gövde
Yüksek geçirgenlikli şeffaf pleksi
Yükseklik ayarı yapılabilen çelik askı teli
Elektrostatik toz boyalı

Aluminium body
transparent plexiglass
Steel wire for installation, which enables the
variation of the height of the luminary
Electrostatic coating







SIVA ÜSTÜ ve SIVA ALTI APLİKLER
wall mounted and recessed lights



CODE : **54.015** LINEAR

IP20

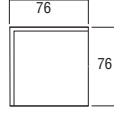
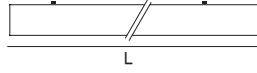

SYS. POWER	COLOR TEMP.	LUM.FLUX	L(mm)
18W	3000K	2200 LM	600 mm
	4000K	2400 LM	
27W	3000K	3300 LM	900 mm
	4000K	3600 LM	
36W	3000K	3600 LM	1200 mm
	4000K	3800 LM	

Ral 9005

Ral 9006

Ral 9016

• Tüm RAL seçenekleri / All colors available





CODE : **30.055**

Teknik Çizim / Technical drawing

SMD LED

18W / 2200 lm.

2700K, 3000K, 4000K, 6500K

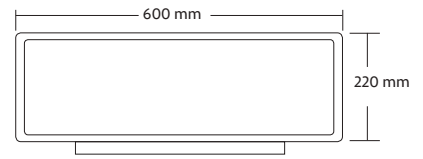

CE IP20

Ral 9005

Ral 9006

Ral 9016

• Tüm RAL seçenekleri / All colors available

Alüminyum gövde

Led driver

Özel taramalı pleksi

Elektrostatik toz boyalı

Direk-endirek aydınlatma

Opsiyonel Dali (isteğe bağlı)

Aluminium body

Led driver

Special scanning plexi

Direct-indirect lighting

Electrostatic coating

Optional Dali dim options



CODE : **30.065**

⊕ DALI CE V IP40

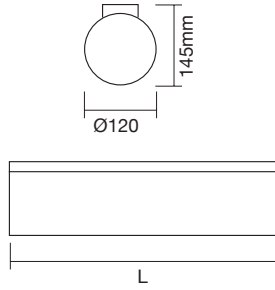

SYS. POWER	COLOR TEMP.	LUM.FLUX	L(mm)
18W	3000K	2200 lm	600 mm
	4000K	2400 lm	
27W	3000K	3300 lm	900 mm
	4000K	3600 lm	
36W	3000K	4400 lm	1200 mm
	4000K	4600 lm	

Ral 9005

Ral 9006

Ral 9016

• Tüm RAL seçenekleri / All colors available

Alüminyum gövde

Led driver

Işık geçirgenliği yüksek opal pleksi

Elektrostatik toz boyalı

Opsiyonel Dali (isteğe bağlı)

Aluminium body

Led driver

Opal PMMA difuser.

Electrostatic coating

Optional Dali dim options





CODE : **30.060**

Teknik Çizim / Technical drawing

SMD LED

18W / 2200 lm.

2700K, 3000K, 4000K, 6500K



CODE : **30.061**

Teknik Çizim / Technical drawing

SMD LED

36W / 4400 lm.

2700K, 3000K, 4000K, 6500K

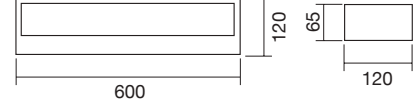

Ral 9005

Ral 9006

Ral 9016

• Tüm RAL seçenekleri / All colors available

Alüminyum gövde

Isıya dayanıklı temperli cam

Elektrostatik toz boyalı

Direk-endirek aydınlatma

Opsiyonel Dali (isteğe bağlı)

Aluminium body

Tempered glass

Direct-indirect lighting

Electrostatic coating

Optional Dali dim options



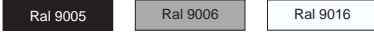

• Tüm RAL seçenekleri / All colors available

Alüminyum gövde
Led driver
Işık geçirgenliği yüksek opal pleksi
Elektrostatik toz boyalı
Direk-endirek aydınlatma
Opsiyonel Dali (isteğe bağlı)

Aluminium body
Led driver
Opal PMMA difuser.
Direct-indirect lighting
Electrostatic coating
Optional Dali dim options

CODE : **30.022**

Teknik Çizim / Technical drawing

SMD LED

36W / 4400 lm.

2700K, 3000K, 4000K, 6500K

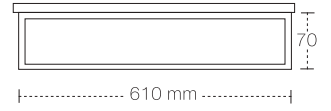

CODE : **30.023**

Teknik Çizim / Technical drawing

SMD LED

72W / 8800 lm.

2700K, 3000K, 4000K, 6500K

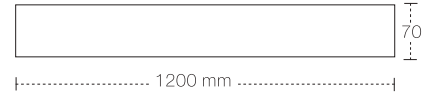



CODE : **30.035**

SMD LED

18W / 2200 lm.

2700K, 3000K, 4000K, 6500K

Teknik Çizim / Technical drawing

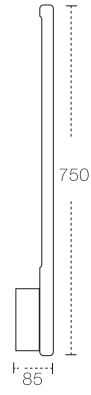

  IP20

Ral 9005

Ral 9006

Ral 9016

• Tüm RAL seçenekleri / All colors available

Pirinç üzeri elektrostatik kaplama

Brass covering electrostatic plated





□ CE IP40

Ral 9005

Ral 9006

Ral 9016

• Tüm RAL seçenekleri / All colors available

CODE : **30.061**

Teknik Çizim / Technical drawing

SMD LED Modul

10W / 1200 lm.

2700K, 3000K, 4000K

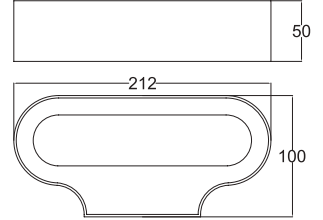

Alüminyum gövde
Işık geçirgenliği yüksek opal pleksi
Elektrostatik toz boyalı
Led driver
Opsiyonel Dali (isteğe bağlı)

Aluminium body
Opal PMMA difuser.
Electrostatic coating
Led Driver
Optional Dali dim options



□ CE IP40

Ral 9005

Ral 9006

Ral 9016

• Tüm RAL seçenekleri / All colors available

CODE : **30.062**

Teknik Çizim / Technical drawing

SMD LED Modul

10W / 1200 lm.

2700K, 3000K, 4000K

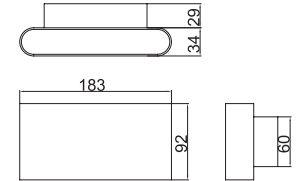

Alüminyum gövde
Işık geçirgenliği yüksek opal pleksi
Elektrostatik toz boyalı
Led driver
Opsiyonel Dali (isteğe bağlı)

Aluminium body
Opal PMMA difuser.
Electrostatic coating
Led Driver
Optional Dali dim options



CODE : **30.055**

SMD LED modul

7W / 600 lm.

2700K, 3000K, 4000K

Teknik Çizim / Technical drawing

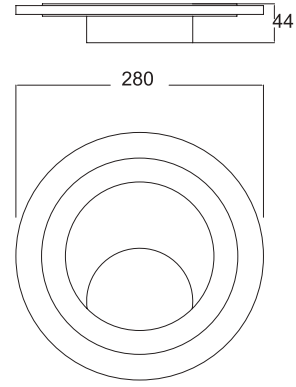

   IP40

Ral 9005

Ral 9006

Ral 9016

• Tüm RAL seçenekleri / All colors available

Alüminyum gövde
Işık geçirgenliği yüksek opal pleksi
Elektrostatik toz boyalı
Opsiyonel Dali (isteğe bağlı)

Aluminium body
Opal PMMA difuser.
Electrostatic coating
Optional Dali dim options



Ral 9005

Ral 9006

Ral 9016

• Tüm RAL seçenekleri / All colors available

CODE : **30.050**

SMD LED modul

9W / 900 lm.

2700K, 3000K, 4000K

Alüminyum gövde
Işık geçirgenliği yüksek opal pleksi
Elektrostatik toz boyalı
Opsiyonel Dali (isteğe bağlı)

Aluminium body
Opal PMMA difuser.
Electrostatic coating
Optional Dali dim options

Teknik Çizim / Technical drawing

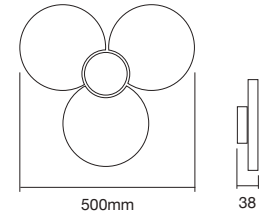

Ral 9005

Ral 9006

Ral 9016

• Tüm RAL seçenekleri / All colors available

CODE : **30.051**

SMD LED modul

3W / 300 lm.

2700K, 3000K, 4000K

Alüminyum gövde
Işık geçirgenliği yüksek opal pleksi
Elektrostatik toz boyalı
Opsiyonel Dali (isteğe bağlı)

Aluminium body
Opal PMMA difuser.
Electrostatic coating
Optional Dali dim options

Teknik Çizim / Technical drawing

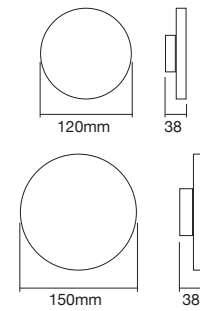



Alüminyum gövde
Işık geçirgenliği yüksek opal pleksi
Elektrostatik toz boyalı
Opsiyonel DALI (isteğe bağlı)

Aluminium body
Opal PMMA difuser.
Electrostatic coating
Optional DALI dim options



□ CE IP40

Ral 9005

Ral 9006

Ral 9016

• Tüm RAL seçenekleri / All colors available

CODE : **30.019**

Teknik Çizim / Technical drawing

SMD LED modul

6W / 600 lm.

2700K, 3000K, 4000K

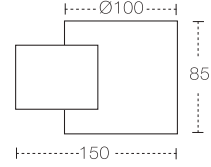

□ CE IP40

Ral 9005

Ral 9006

Ral 9016

• Tüm RAL seçenekleri / All colors available

CODE : **30.020**

Teknik Çizim / Technical drawing

SMD LED modul

12W / 1200 lm.

2700K, 3000K, 4000K

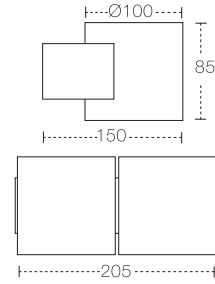



RAYLI SPOTLAR track lights



CE IP20

Ral 9005

Ral 9006

Ral 9016

• Tüm RAL seçenekleri / All colors available

CODE : **20.010**

COB LED

14W / 1800 lm.

2700K, 3000K, 4000K

Alüminyum enjeksiyon gövde
Alüminyum led soğutucu
Led driver
Isıya dayanıklı cam
Yüksek saflıkta alüminyum reflektör
Dar, orta ve geniş açılı reflektör seçeneği
Elektrostatik toz boyalı

Die-cast aluminium body
Aluminium heatsink
Led driver
Tempered glass
High purity aluminium reflector
Narrow, Medium and Wide angle reflectors
Electrostatic coating

Teknik Çizim / Technical drawing

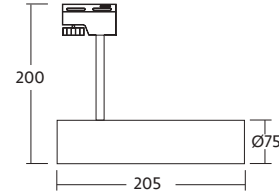

CE IP20

Ral 9005

Ral 9006

Ral 9016

• Tüm RAL seçenekleri / All colors available

CODE : **20.020**

COB LED

20W / 2800 - 30W / 4200 lm

2700K, 3000K, 4000K, 6000K

Alüminyum enjeksiyon gövde
Alüminyum led soğutucu
Led driver
Isıya dayanıklı cam
Yüksek saflıkta alüminyum reflektör
Dar, orta ve geniş açılı reflektör seçeneği
Elektrostatik toz boyalı

Die-cast aluminium body
Aluminium heatsink
Led driver
Tempered glass
High purity aluminium reflector
Narrow, Medium and Wide angle reflectors
Electrostatic coating

Teknik Çizim / Technical drawing

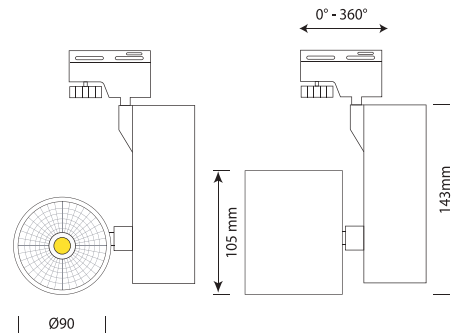



Ral 9005

Ral 9006

Ral 9016

• Tüm RAL seçenekleri / All colors available

CODE : **20.030**

COB LED

20W / 2800 - 30W / 4200 lm

2700K, 3000K, 4000K, 6000K

Alüminyum enjeksiyon gövde
Alüminyum led soğutucu
Led driver
Isıya dayanıklı cam
Yüksek saflıkta alüminyum reflektör
Dar, orta ve geniş açılı reflektör seçeneği
Elektrostatik toz boyalı

Die-cast aluminium body
Aluminium heatsink
Led driver
Tempered glass
High purity aluminium reflector
Narrow, Medium and Wide angle reflectors
Electrostatic coating

Teknik Çizim / Technical drawing

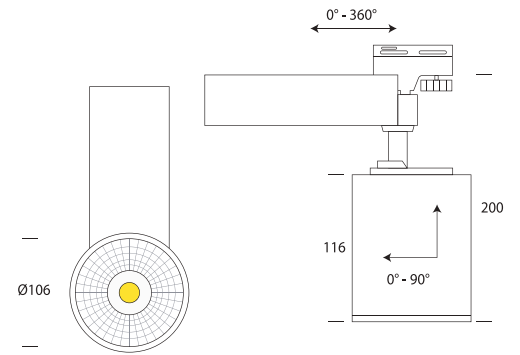

Ral 9005

Ral 9006

Ral 9016

• Tüm RAL seçenekleri / All colors available

CODE : **220.040**

COB LED

20W / 2800 - 30W / 4200 lm

2700K, 3000K, 4000K, 6000K

Alüminyum enjeksiyon gövde
Alüminyum led soğutucu
Led driver
Isıya dayanıklı cam
Yüksek saflıkta alüminyum reflektör
Dar, orta ve geniş açılı reflektör seçeneği
Elektrostatik toz boyalı

Die-cast aluminium body
Aluminium heatsink
Led driver
Tempered glass
High purity aluminium reflector
Narrow, Medium and Wide angle reflectors
Electrostatic coating

Teknik Çizim / Technical drawing

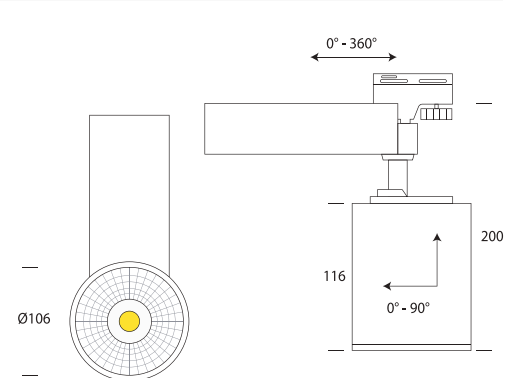





DEKORATİF OFİS ve
OTEL ARMATÜRLERİ
decorative office and
hotelluminaires



DKP gövde kaplama
Elektrostatik toz boyalı

DKP body covering
Electrostatic powder coating



Beyaz / White
 Gri / Gray
 Siyah / Black

IP20

KOD	LAMBA TİPİ
60.001	1x23W E27

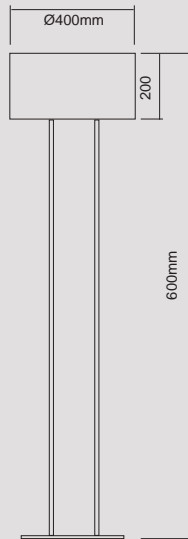

CODE : **60.002**

Teknik Çizim / Technical drawing

SMD LED

18W / 2200 lm.

2700K, 3000K, 4000K, 6500K



IP20

Ral 9005

Ral 9006

Ral 9016

• Tüm RAL seçenekleri / All colors available

Alüminyum gövde

Led driver

Özel taramalı pleksi

Elektrostatik toz boyalı

Direk-endirek aydınlatma

Opsiyonel Dalı (isteğe bağlı)

Aluminium body

Led driver

Special scanning plexi

Direct-indirect lighting

Electrostatic coating

Optional Dalı dim options

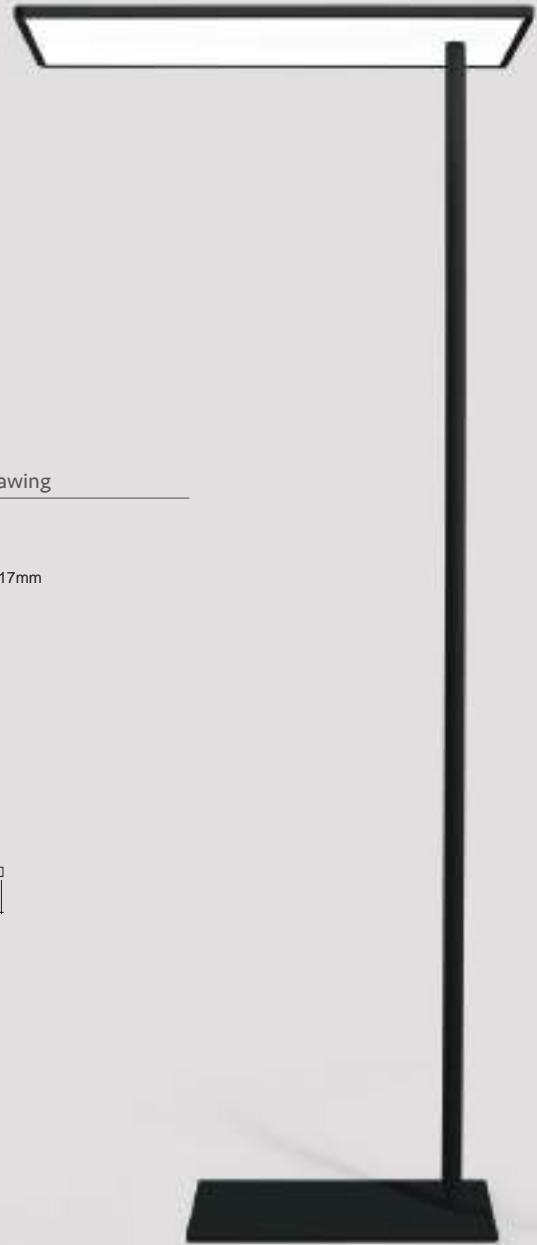
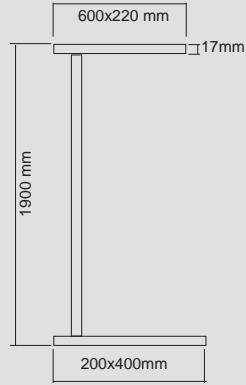



Alüminyum gövde
Akrilik pleksi
Elektrostatik toz boyalı

Aluminium body
Acrylic plexi
Electrostatic powder coating



T5 / G5

Beyaz / White

Gri / Gray

Siyah / Black

 IP20

KOD

60.060

LAMBA TİPİ

63W

7560 lm

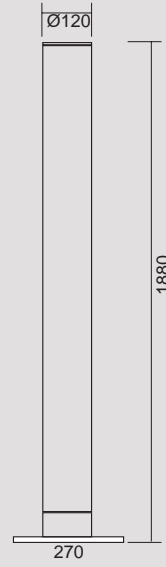



Alüminyum gövde
Akrilik pleksi
Elektrostatik toz boyalı

Aluminium body
Acrylic plexi
Electrostatic powder coating



Beyaz / White
 Gri / Gray
 Siyah / Black

IP20

KOD	LAMBA TİPİ	
60.061	54W	6400 lm

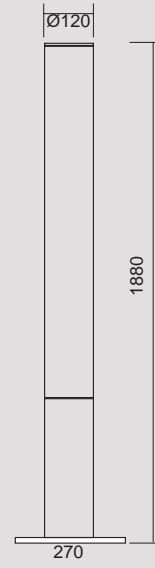



Ledli okuma lambası
DKP gövde kaplama
Elektrostatik toz boyalı

Led reading lamp
DKP body covering
Electrostatic powder coating

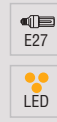
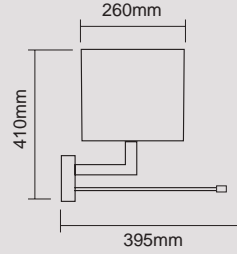

□ Beyaz / White
□ Gri / Gray
■ Siyah / Black

IP20

KOD **LAMBA TİPİ**
60.110 1x18W + 1W Power Led E27+LED



Ledli okuma lambası
DKP gövde kaplama
Elektrostatik toz boyalı

Led reading lamp
DKP body covering
Electrostatic powder coating

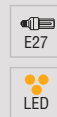
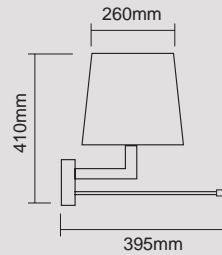

□ Beyaz / White
□ Gri / Gray
■ Siyah / Black

IP20

KOD **LAMBA TİPİ**
60.111 1x18W + 1W Power Led E27+LED



pirinç gövde
Krom veya saten kaplamalı

Brass body
Or satin chrome-plated

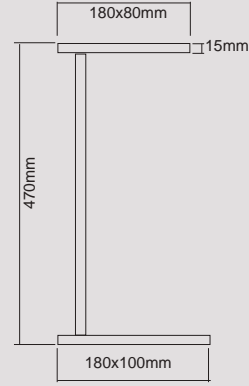

F ⊕ IP20

KOD **LAMBA TİPİ**
60.130 SMD LED 8W 1000 lm.



CODE : **60.120**

Power LED

1W / 143 lm.

Alüminyum gövde
Led driver
Elektrostatik toz boyalı

Aluminium body
Led driver
Electrostatic coating

Teknik Çizim / Technical drawing

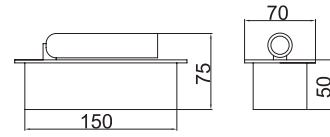

□ CE IP20

Ral 9005

Ral 9006

Ral 9016

• Tüm RAL seçenekleri / All colors available





DIŐ ve ENDÜSTRİYEL
AYDINLATMA
outdoor industrial
lighting



CODE : **70.110**

Teknik Çizim / Technical drawing

SMD LED Modul

70W / 9100 lm.

2700K, 3000K, 4000K, 6500K

   IP54

Ral 9005

Ral 9006

Ral 9016

• Tüm RAL seçenekleri / All colors available

Alüminyum gövde

Akrilik pleksi

Elektrostatik toz boyalı

Aluminium body

Acrylic plexi

Electrostatic coating

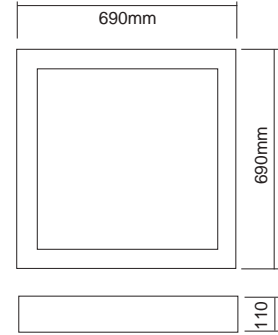

CODE : **70.370**

Teknik Çizim / Technical drawing

LED

18W / 2150 lm.

2700K, 3000K, 4000K, 6500K

   IP54

Ral 9005

Ral 9006

Ral 9016

• Tüm RAL seçenekleri / All colors available

Alüminyum gövde

Polikarbon cam

Elektrostatik toz boyalı

Aluminium body

Polycarbonate glass

Electrostatic coating

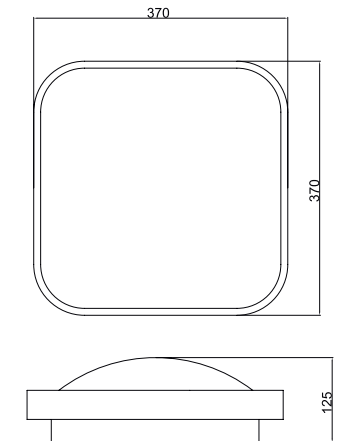



CODE : **70.560**

SMD Led

9W / 1080 lm.

2700K, 3000K, 4000K, 6500K

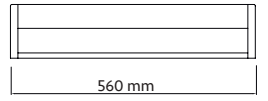

CODE : **70.130**

SMD Led

18W / 20160 lm.

2700K, 3000K, 4000K, 6500K

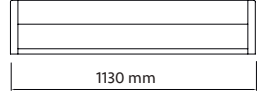

CODE : **70.168**

SMD Led

27W / 3240 lm.

2700K, 3000K, 4000K, 6500K

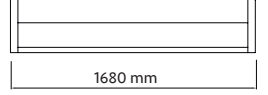

  IP54

Ral 9005

Ral 9006

Ral 9016

• Tüm RAL seçenekleri / All colors available

Alüminyum & PMMA gövde
Elektrostatik toz boyalı

Aluminium & PMMA body
Electrostatic coating

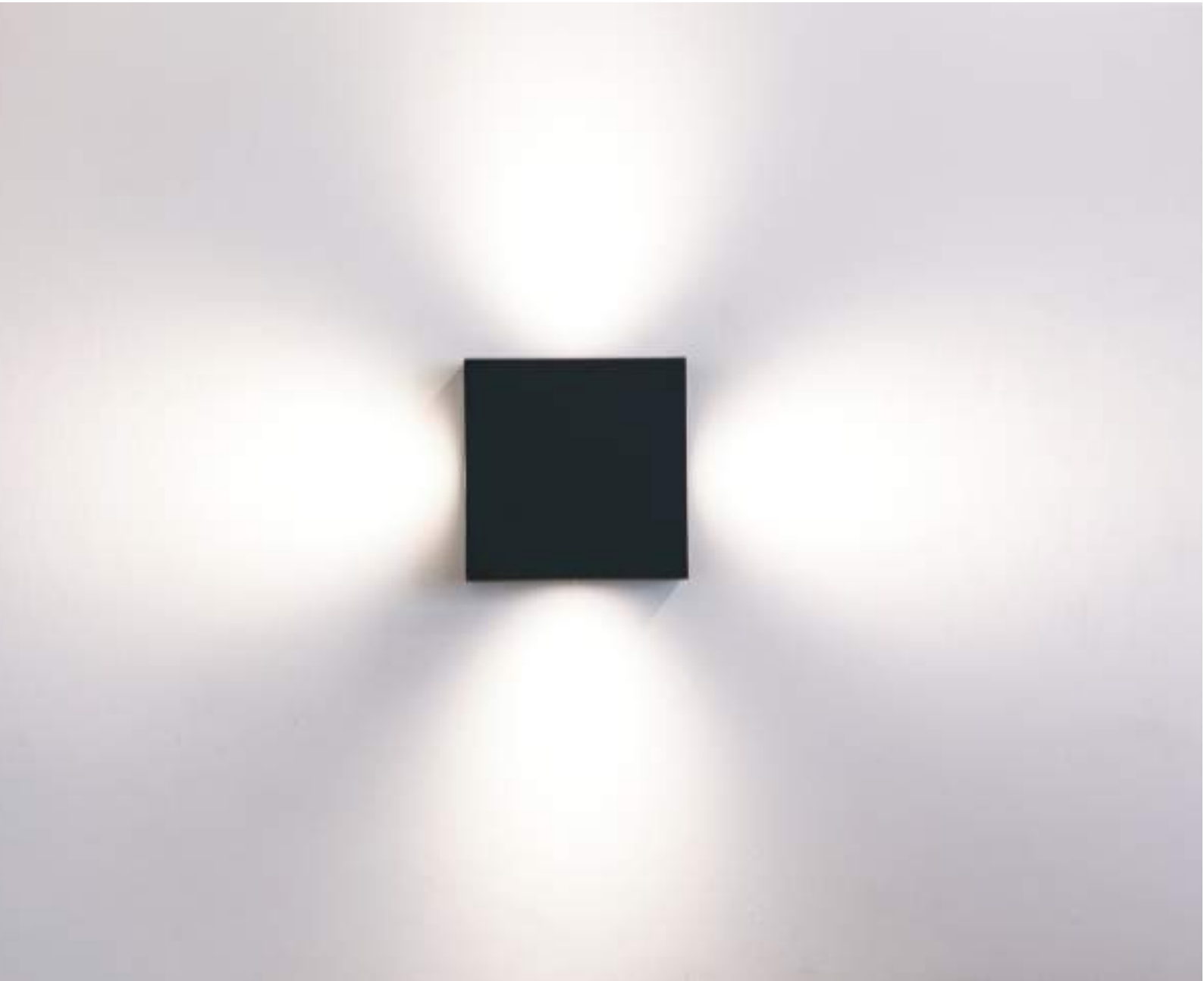



CODE : **70.060**

Power Led

1W / 120 lm.

2700K, 3000K, 4000K, 6500K

   IP54

Ral 9005

Ral 9006

Ral 9016

• Tüm RAL seçenekleri / All colors available

Alüminyum gövde
Dar, orta ve geniş açılı lens.
Elektrostatik toz boyalı

Aluminium body
Narrow, medium and wide angle lens.
Electrostatic coating

35mm

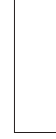

65mm

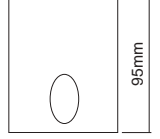

95mm



CODE : **70.061**

Teknik Çizim / Technical drawing

Power Led

4x1W / 480 lm.

2700K, 3000K, 4000K, 6500K

   IP54

Ral 9005

Ral 9006

Ral 9016

• Tüm RAL seçenekleri / All colors available

Alüminyum gövde
Dar, orta ve geniş açılı lens.
Elektrostatik toz boyalı

Aluminium body
Narrow, medium and wide angle lens.
Electrostatic coating

50mm



110mm



110mm





CODE : **70.062**

Power LED

1W / 143 lm.

2700K, 3000K, 4000K, 6500K

   IP54

Ral 9005

Ral 9006

Ral 9016

• Tüm RAL seçenekleri / All colors available

Alüminyum gövde
Elektrostatik toz boyalı

DKP body
Electrostatic coating

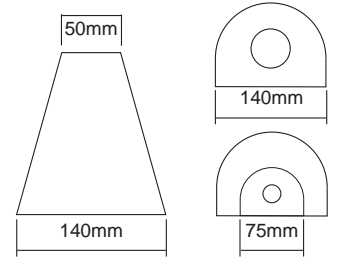

CODE : **70.063**

Teknik Çizim / Technical drawing

Power LED

2x1W / 2x143 lm.

2700K, 3000K, 4000K, 6500K

   IP54

Ral 9005

Ral 9006

Ral 9016

• Tüm RAL seçenekleri / All colors available

Alüminyum gövde
Elektrostatik toz boyalı

DKP body
Electrostatic coating

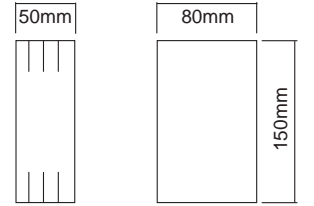



CODE : **70.013**

Teknik Çizim / Technical drawing

LED

15W / 950 lm.

2700K, 3000K, 4000K, 6500K

   IP54

Ral 9005

Ral 9006

Ral 9016

• Tüm RAL seçenekleri / All colors available

Alüminyum gövde
Isıya dayanıklı cam
Elektrostatik toz boyalı

Aluminium body
Tempered glass
Electrostatic coating

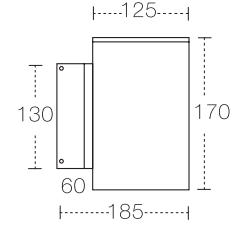

CODE : **70.014**

Teknik Çizim / Technical drawing

LED

2x15W / 2x1950 lm.

2700K, 3000K, 4000K, 6500K

   IP54

Ral 9005

Ral 9006

Ral 9016

• Tüm RAL seçenekleri / All colors available

Alüminyum gövde
Isıya dayanıklı cam
Elektrostatik toz boyalı

Aluminium body
Tempered glass
Electrostatic coating

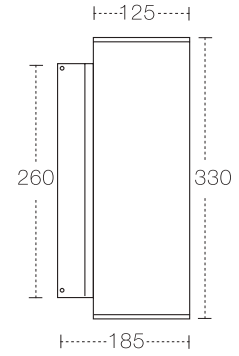





CODE : **70.080**

Teknik Çizim / Technical drawing

LED

1W / 143 lm.

2700K, 3000K, 4000K, 6500K

   IP44

Ral 9005 Ral 9006 Ral 9016

• Tüm RAL seçenekleri / All colors available

Alüminyum gövde
Opal pleksiglas
Elektrostatik toz boyalı

Aluminium body
Opal plexiglass
Electrostatic coating

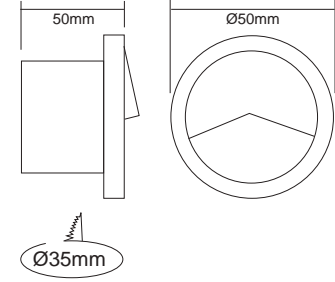

CODE : **70.082**

Teknik Çizim / Technical drawing

LED

1W / 143 lm.

2700K, 3000K, 4000K, 6500K

   IP54

Ral 9005 Ral 9006 Ral 9016

• Tüm RAL seçenekleri / All colors available

Alüminyum gövde
Elektrostatik toz boyalı

Aluminium body
Electrostatic coating

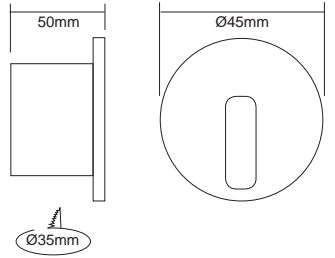

CODE : **70.083**

Teknik Çizim / Technical drawing

LED

1W / 143 lm.

2700K, 3000K, 4000K, 6500K

   IP54

Ral 9005 Ral 9006 Ral 9016

• Tüm RAL seçenekleri / All colors available

Alüminyum gövde
Elektrostatik toz boyalı

Aluminium body
Electrostatic coating

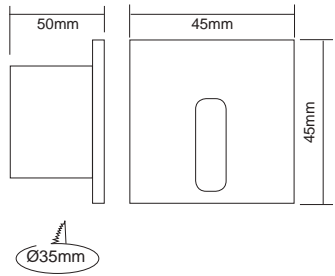

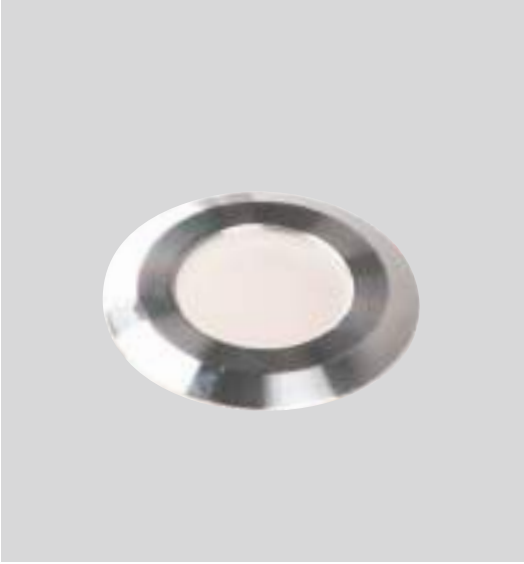

CODE : **70.084**

LED

1W / 130 lm

2700K, 3000K, 4000K, 6500K

CE IP54

Ral 9005

Ral 9006

Ral 9016

• Tüm RAL seçenekleri / All colors available

Alüminyum gövde
Akrilik difüzör
Elektrostatik toz boyalı

Aluminium body
Acrylic diffuser
Electrostatic powder coating

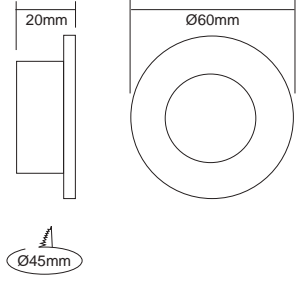

70.084 SMD LED



CODE : **70.090**

SMD LED Modul

1x3W / 429 lm.

2700K, 3000K, 4000K, 6500K

CE IP54

Ral 9005

Ral 9006

Ral 9016

• Tüm RAL seçenekleri / All colors available

Alüminyum gövde
Paslanmaz çelik çerçeve
Isıya dayanıklı cam
Elektrostatik toz boyalı

Aluminium body
Stainless steel frame
Tempered glass
Electrostatic coating

Teknik Çizim / Technical drawing

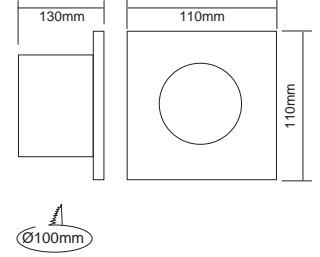

CODE : **70.091**

SMD LED Modul

1x3W / 429 lm.

2700K, 3000K, 4000K, 6500K

CE IP54

Ral 9005

Ral 9006

Ral 9016

• Tüm RAL seçenekleri / All colors available

Alüminyum gövde
Paslanmaz çelik çerçeve
Isıya dayanıklı cam
Elektrostatik toz boyalı

Aluminium body
Stainless steel frame
Tempered glass
Electrostatic coating

Teknik Çizim / Technical drawing

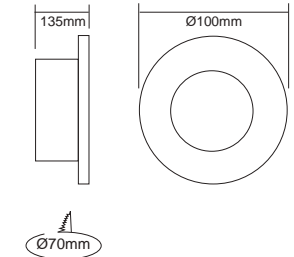



CE IP68

Ral 9005

Ral 9006

• Tüm RAL seçenekleri / All colors available

CODE : **70.2041**

Teknik Çizim / Technical drawing

Power LED

3W / 459 lm

2700K, 3000K, 4000K, 6500K

Polyol RIM gövde
Opal & Şeffaf PMMA
Uzun ömürlü paslanma yapmayan Polyol
RIM teknolojisi ile üretilmiştir.

Polyol RIM body.
Opal & Transparent PMMA
It is produced with Polyol RIM technology
which does not make long lasting
corrosion.

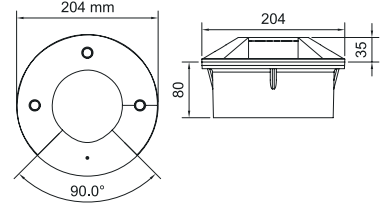

CE IP68

Ral 9005

Ral 9006

• Tüm RAL seçenekleri / All colors available

CODE : **70.2042**

Teknik Çizim / Technical drawing

Power LED

2x3W / 2x459 lm

2700K, 3000K, 4000K, 6500K

Polyol RIM gövde
Opal & Şeffaf PMMA
Uzun ömürlü paslanma yapmayan Polyol
RIM teknolojisi ile üretilmiştir.

Polyol RIM body.
Opal & Transparent PMMA
It is produced with Polyol RIM technology
which does not make long lasting
corrosion.

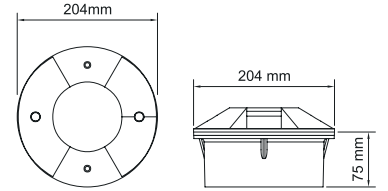

CE IP68

Ral 9005

Ral 9006

• Tüm RAL seçenekleri / All colors available

CODE : **70.2044**

Teknik Çizim / Technical drawing

Power LED

4x1W / 4x153 lm

2700K, 3000K, 4000K, 6500K

Polyol RIM gövde
Opal & Şeffaf PMMA
Uzun ömürlü paslanma yapmayan Polyol
RIM teknolojisi ile üretilmiştir.

Polyol RIM body.
Opal & Transparent PMMA
It is produced with Polyol RIM technology
which does not make long lasting
corrosion.

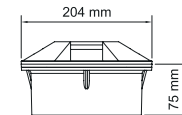



□ CE V IP68

Ral 9005

Ral 9006

• Tüm RAL seçenekleri / All colors available

CODE : **70.1181**

Teknik Çizim / Technical drawing

SMD LED Modul

4.2W / 600 lm

2700K, 3000K, 4000K, 6500K

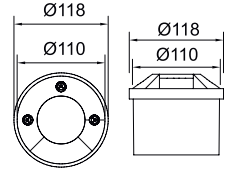

Polyol RIM gövde
Opal & Şeffaf PMMA
Uzun ömürlü paslanma yapmayan Polyol
RIM teknolojisi ile üretilmiştir.

Polyol RIM body.
Opal & Transparent PMMA
It is produced with Polyol RIM technology
which does not make long lasting
corrosion.



□ CE V IP68

Ral 9005

Ral 9006

• Tüm RAL seçenekleri / All colors available

CODE : **70.1182**

Teknik Çizim / Technical drawing

SMD LED Modul

4.2W / / 600 lm

2700K, 3000K, 4000K, 6500K

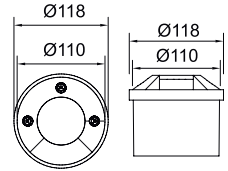

Polyol RIM gövde
Opal & Şeffaf PMMA
Uzun ömürlü paslanma yapmayan Polyol
RIM teknolojisi ile üretilmiştir.

Polyol RIM body.
Opal & Transparent PMMA
It is produced with Polyol RIM technology
which does not make long lasting
corrosion.



□ CE V IP68

Ral 9005

Ral 9006

• Tüm RAL seçenekleri / All colors available

CODE : **70.1184**

Teknik Çizim / Technical drawing

SMD LED Modul

4.2W / / 600 lm

2700K, 3000K, 4000K, 6500K

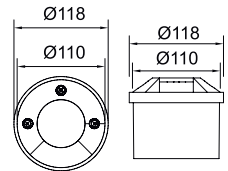

Polyol RIM gövde
Opal & Şeffaf PMMA
Uzun ömürlü paslanma yapmayan Polyol
RIM teknolojisi ile üretilmiştir.

Polyol RIM body.
Opal & Transparent PMMA
It is produced with Polyol RIM technology
which does not make long lasting
corrosion.





CODE : **90.120**

Teknik Çizim / Technical drawing

Mid Power LED

100W / 12000 lm.

2700K, 3000K, 4000K, 6500K

   IP65

Ral 9005

Ral 9006

Ral 9016

• Tüm RAL seçenekleri / All colors available

Alüminyum gövde
Isıya dayanıklı temperli cam
Elektrostatik toz boyalı
Direk-endirek aydınlatma
Opsiyonel Dali (isteğe bağlı)

Aluminium body
Tempered glass
Direct-indirect lighting
Electrostatic coating
Optional Dali dim options

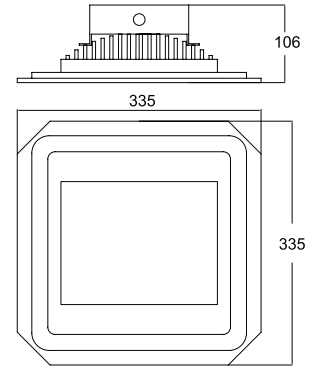

CODE : **90.110**

Teknik Çizim / Technical drawing

Power LED

200W / 24000 lm.

2700K, 3000K, 4000K, 6500K

   IP65

Ral 9005

Ral 9006

Ral 9016

• Tüm RAL seçenekleri / All colors available

Alüminyum gövde
Isıya dayanıklı temperli cam
Elektrostatik toz boyalı
Direk-endirek aydınlatma
Opsiyonel Dali (isteğe bağlı)

Aluminium body
Tempered glass
Direct-indirect lighting
Electrostatic coating
Optional Dali dim options



CODE : **70.520**

Teknik Çizim / Technical drawing

Power Led

20W / 2400 lm

2700K, 3000K, 4000K, 6500K

□ CE IP20

Ral 9005

Ral 9006

Ral 9016

• Tüm RAL seçenekleri / All colors available

Alüminyum gövde
Isıya dayanıklı temperli cam
Elektrostatik toz boyalı
Direk-endirek aydınlatma
Opsiyonel DALI (isteğe bağlı)

Aluminium body
Tempered glass
Direct-indirect lighting
Electrostatic coating
Optional DALI dim options

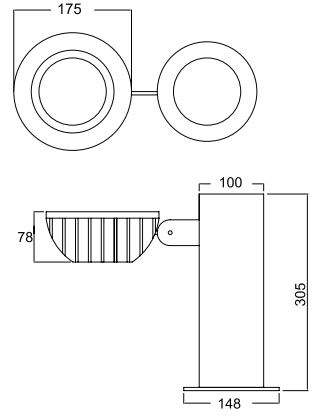



CODE : **70.035**

Teknik Çizim / Technical drawing

Power LED

9x1W / 1287 lm.

2700K, 3000K, 4000K, 6500K

   IP65

Ral 9005

Ral 9006

Ral 9016

• Tüm RAL seçenekleri / All colors available

Alüminyum enjeksiyon gövde
Elektrostatik toz boyalı
Isıya dayanıklı temperli cam

Die cast aluminium body
Electrostatic powder coating
Tempered glass

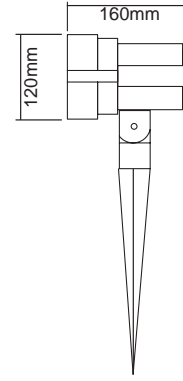

CODE : **70.036**

Teknik Çizim / Technical drawing

Power LED

3x1W / 429 lm.

2700K, 3000K, 4000K, 6500K

   IP20

Ral 9005

Ral 9006

Ral 9016

• Tüm RAL seçenekleri / All colors available

Alüminyum enjeksiyon gövde
Elektrostatik toz boyalı
Isıya dayanıklı temperli cam

Die cast aluminium body
Electrostatic powder coating
Tempered glass

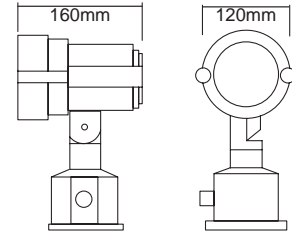



CODE : **70.037**

Teknik Çizim / Technical drawing

Power LED

3x1W / 459 lm.

2700K, 3000K, 4000K, 6500K

Polyol RIM gövde
Temperli cam.
Paslanmaz dış çerçeve
Uzun ömürlü paslanma yapmayan Polyol
RIM teknolojisi ile üretilmiştir.

Polyol RIM body.
Tempered glass
Stainless outer frame
It is produced with Polyol RIM technology
which does not make long lasting
corrosion.

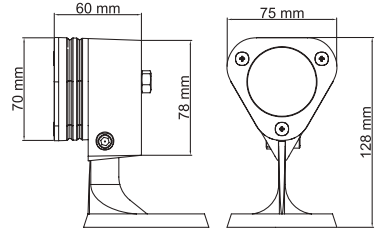

□ CE IP65

Ral 9005

Ral 9006

Ral 9016

• Tüm RAL seçenekleri / All colors available





CODE : **70.501**

Teknik Çizim / Technical drawing

Mid Power LED

15W / 1800 lm.

2700K, 3000K, 4000K, 6500K

□ CE IP54

Ral 9005

Ral 9006

Ral 9016

• Tüm RAL seçenekleri / All colors available

Alüminyum gövde
Elektrostatik toz boyalı
Şeffaf pleksi

Aluminium body
Electrostatic coating
Transparent plexi

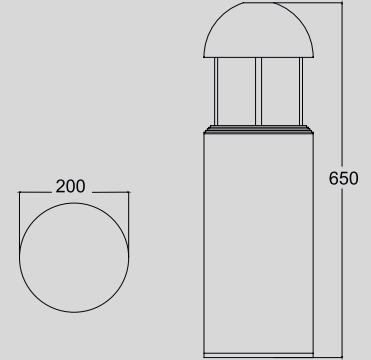





CODE : **70.510**

Teknik Çizim / Technical drawing

COB LED

2x10W / 2x1000 lm.

2700K, 3000K, 4000K, 6500K

   IP54

Ral 9005

Ral 9006

Ral 9016

• Tüm RAL seçenekleri / All colors available

Alüminyum gövde
Isıya dayanıklı temperli cam
Elektrostatik toz boyalı
Direk-endirek aydınlatma
Opsiyonel Dali (isteğe bağlı)

Aluminium body
Tempered glass
Direct-indirect lighting
Electrostatic coating
Optional Dali dim options

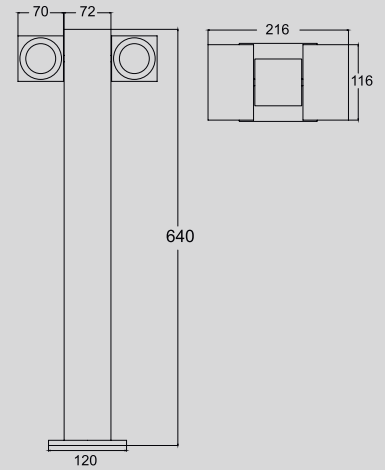



CODE : **70.010**

Teknik Çizim / Technical drawing

SMD LED

10W / 1300 lm.

2700K, 3000K, 4000K, 6500K

□ CE IP54

Ral 9005

Ral 9006

Ral 9016

• Tüm RAL seçenekleri / All colors available

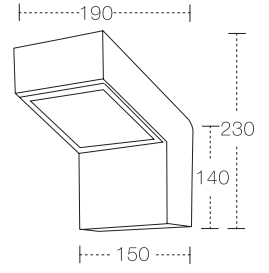

Alüminyum gövde
Elektrostatik toz boyalı
Opal peksi

Aluminium body
Electrostatic coating
Opal plexiglass



CODE : **70.004**

Teknik Çizim / Technical drawing

SMD LED

10W / 1300 lm.

2700K, 3000K, 4000K, 6500K

□ CE IP54

Ral 9005

Ral 9006

Ral 9016

• Tüm RAL seçenekleri / All colors available

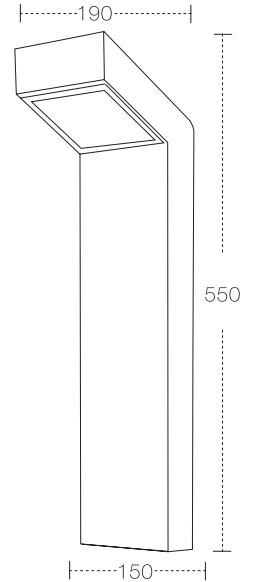

Alüminyum gövde
Elektrostatik toz boyalı
Opal peksi

Aluminium body
Electrostatic coating
Opal plexiglass



CODE : **70.002**

Teknik Çizim / Technical drawing

SMD LED

10W / 1300 lm.

2700K, 3000K, 4000K, 6500K

   IP54

Ral 9005

Ral 9006

Ral 9016

• Tüm RAL seçenekleri / All colors available

Alüminyum gövde
Elektrostatik toz boyalı
Opal peksi

Aluminium body
Electrostatic coating
Opal plexiglass

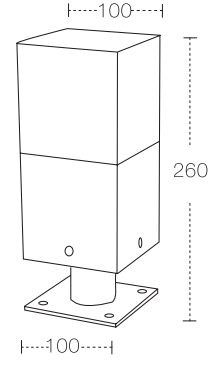

CODE : **70.040**

Teknik Çizim / Technical drawing

E27

10W

   IP54

Ral 9005

Ral 9006

Ral 9016

• Tüm RAL seçenekleri / All colors available

Alüminyum gövde
Elektrostatik toz boyalı
Şeffaf pleksi

Aluminium body
Electrostatic coating
Transparent plexi

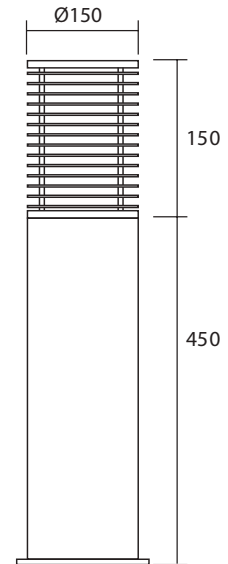



CODE : **70.005**

Teknik Çizim / Technical drawing

E27

10W

   IP54

Ral 9005

Ral 9006

Ral 9016

• Tüm RAL seçenekleri / All colors available

Alüminyum gövde
Elektrostatik toz boyalı
Şeffaf pleksi

Aluminium body
Electrostatic coating
Transparent plexi

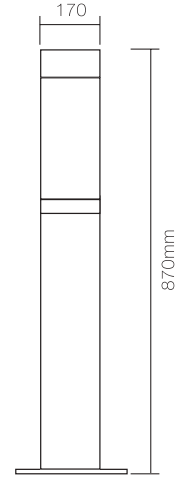

CODE : **70.040**

Teknik Çizim / Technical drawing

E27

10W

   IP54

Ral 9005

Ral 9006

Ral 9016

• Tüm RAL seçenekleri / All colors available

Alüminyum gövde
Elektrostatik toz boyalı
Opal peksi

Aluminium body
Electrostatic coating
Opal plexiglass

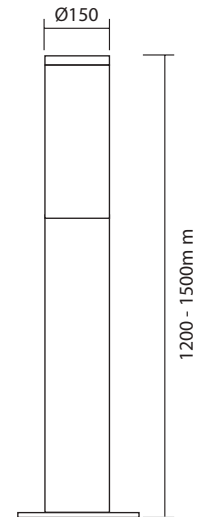

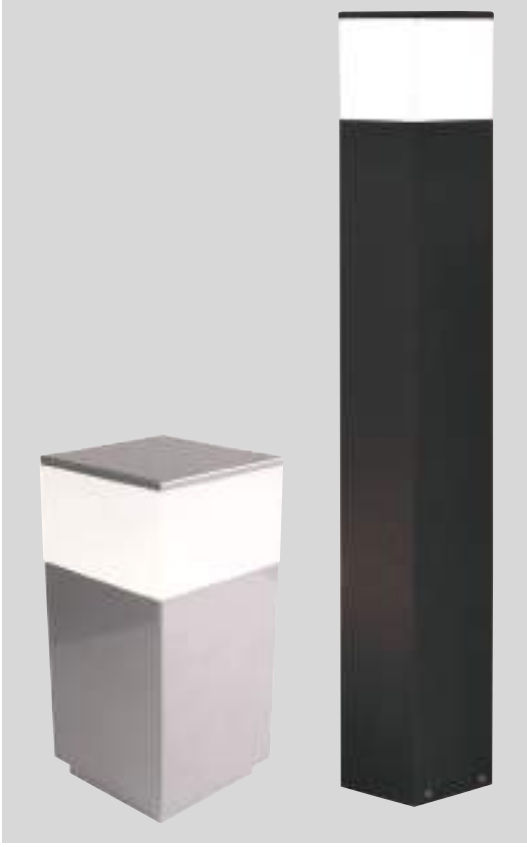

CODE : **70.055**

Teknik Çizim / Technical drawing

E27

10W

□ CE IP54

Ral 9005

Ral 9006

Ral 9016

• Tüm RAL seçenekleri / All colors available

DKP gövde
Elektrostatik toz boyalı
Opal peksi

DKP body
Electrostatic coating
Opal plexiglass

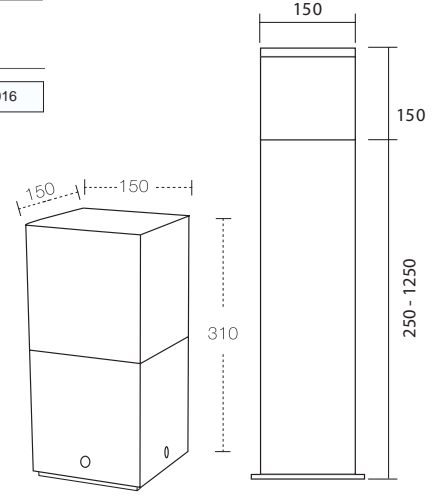

CODE : **70.051**

Teknik Çizim / Technical drawing

E27

10W

□ CE IP54

Ral 9005

Ral 9006

Ral 9016

• Tüm RAL seçenekleri / All colors available

DKP & Alüminyum gövde
Elektrostatik toz boyalı
Opal peksi

DKP & Aluminium body
Electrostatic coating
Opal plexiglass

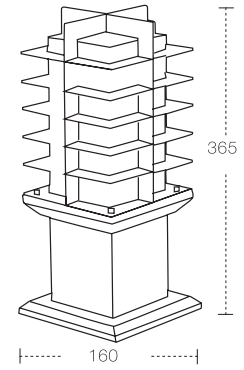

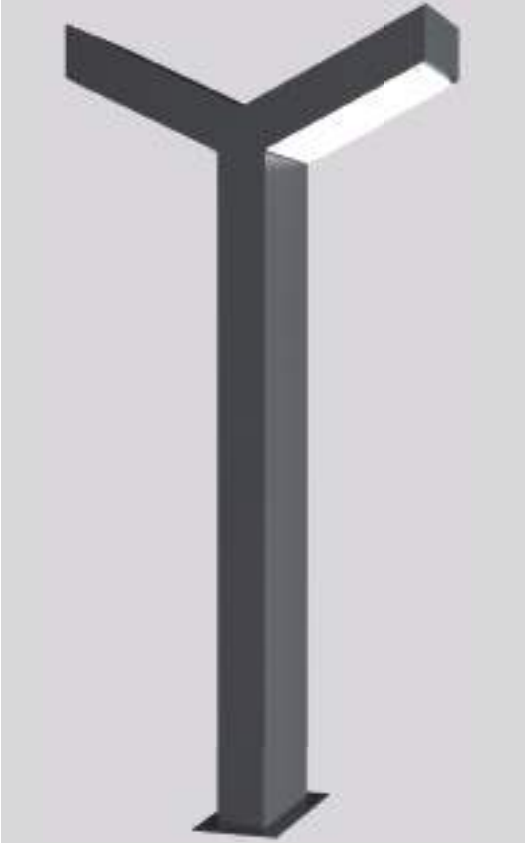

CODE : **70.8025**

Teknik Çizim / Technical drawing

SMD LED

2x15W / 2x1800 lm.

2700K, 3000K, 4000K, 6500K



Ral 9005

Ral 9006

Ral 9016

• Tüm RAL seçenekleri / All colors available

Alüminyum gövde
Elektrostatik toz boyalı
Şeffaf pleksi

Aluminium body
Electrostatic coating
Transparent plexi

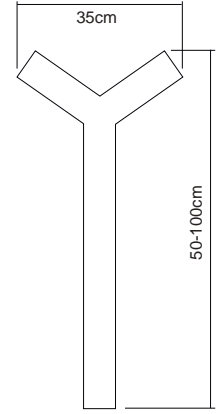

CODE : **70.8015**

Teknik Çizim / Technical drawing

SMD LED

15W / 1800 lm.

2700K, 3000K, 4000K, 6500K



Ral 9005

Ral 9006

Ral 9016

• Tüm RAL seçenekleri / All colors available

Alüminyum gövde
Elektrostatik toz boyalı
Opal peksi

Aluminium body
Electrostatic coating
Opal plexiglass

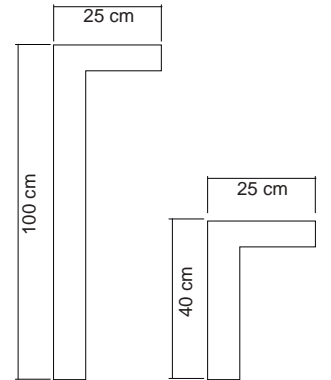

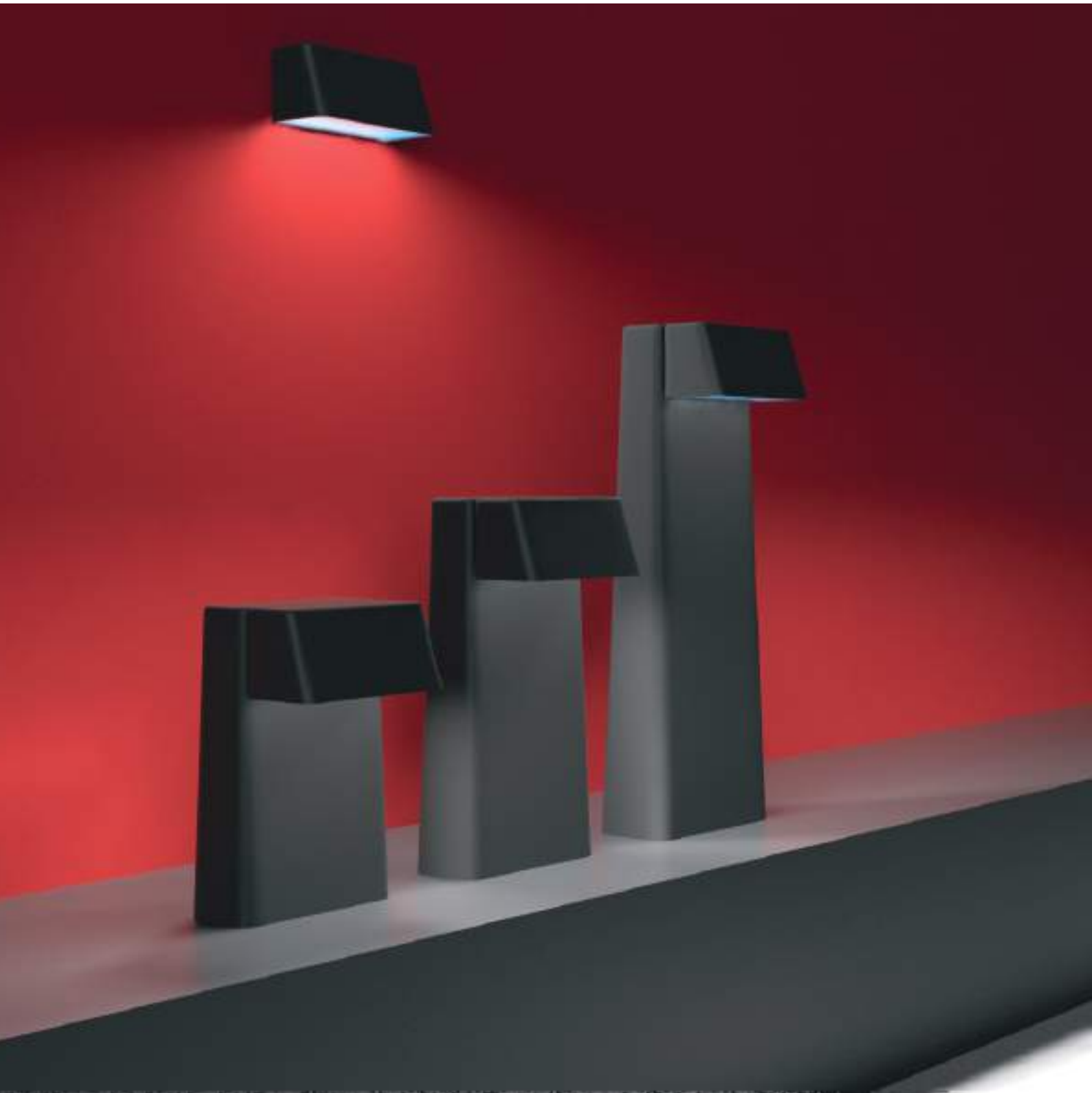



CODE : **70.331**

Teknik Çizim / Technical drawing

SMD Led Modul

12W / 1440 lm.

2700K, 3000K, 4000K, 6500K

   IP54

Ral 9005

Ral 9006

Ral 9016

• Tüm RAL seçenekleri / All colors available

Polyol RIM gövde
Opal & Şeffaf PMMA
Uzun ömürlü paslanma yapmayan Polyol
RIM teknolojisi ile üretilmiştir.

Polyol RIM body.
Opal & Transparent PMMA
It is produced with Polyol RIM technology
which does not make long lasting
corrosion.

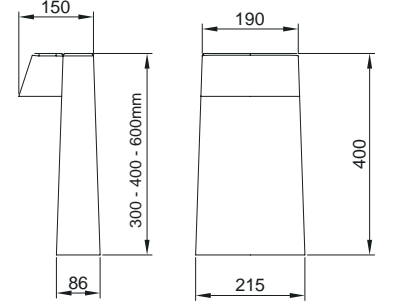



CODE : **70.330**

Teknik Çizim / Technical drawing

SMD Led Modul

12W / 1440 lm.

2700K, 3000K, 4000K, 6500K

CE IP54

Ral 9005 Ral 9006 Ral 9016

• Tüm RAL seçenekleri / All colors available

DKP gövde
Elektrostatik toz boyalı
Opal peksi

DKP body
Electrostatic coating
Opal plexiglass

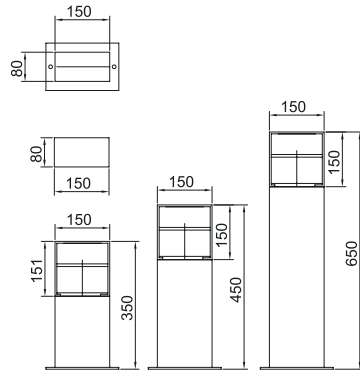

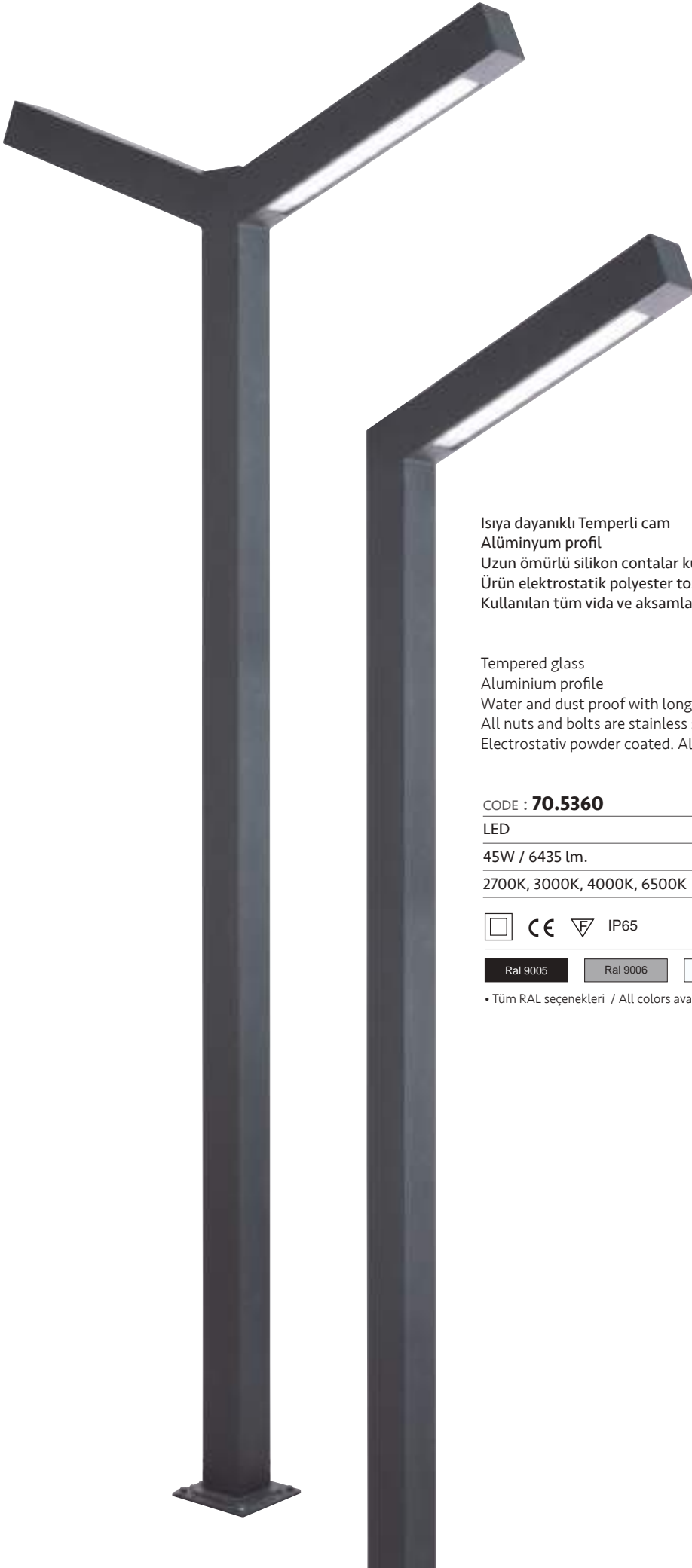

Isiya dayanıklı Temperli cam
Alüminyum profil
Uzun ömürlü silikon contalar kullanılmaktadır.
Ürün elektrostatik polyster toz boya ile tüm RAL renklerinde boyanabilir.
Kullanılan tüm vida ve aksesuarlar paslanmaz çeliktir.

Tempered glass
Aluminium profile
Water and dust proof with long-lasting silicon seals.
All nuts and bolts are stainless steel.
Electrostativ powder coated. All RAL codes could be applied.

CODE : **70.5360**

Teknik Çizim / Technical drawing

LED

45W / 6435 lm.

2700K, 3000K, 4000K, 6500K

   IP65

Ral 9005

Ral 9006

Ral 9016

• Tüm RAL seçenekleri / All colors available

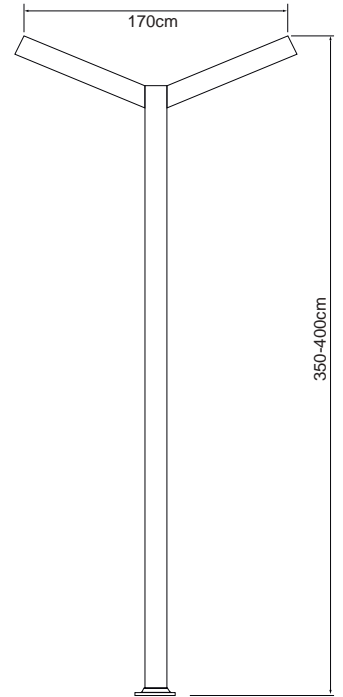

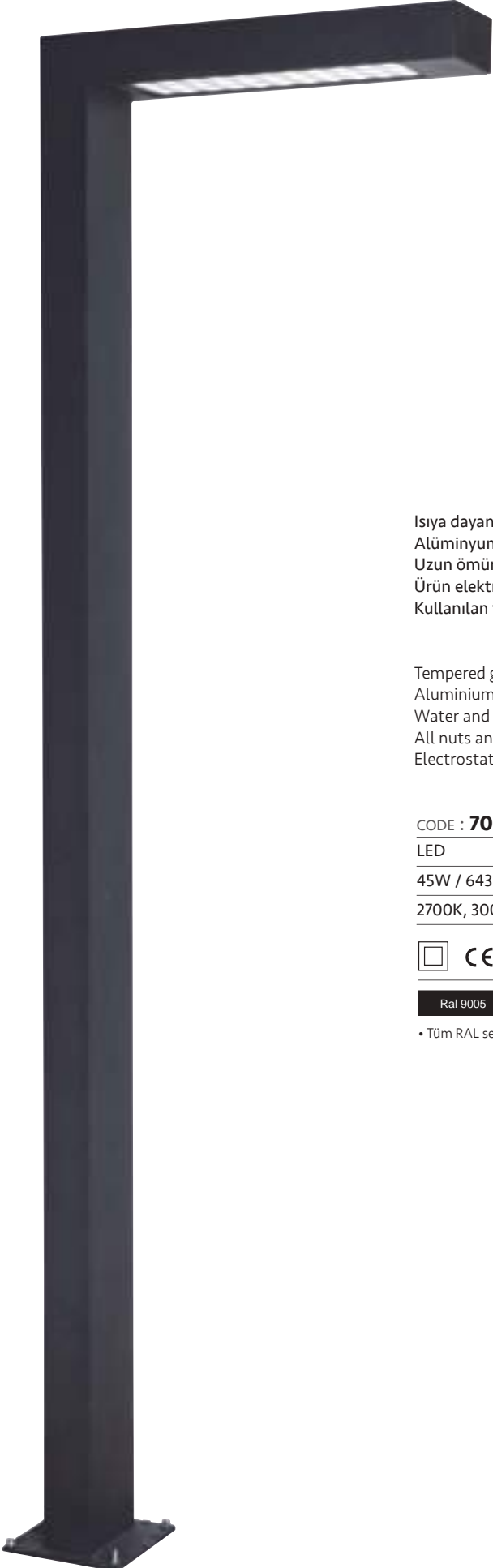

Isiya dayanıklı Temperli cam
Alüminyum profil
Uzun ömürlü silikon contalar kullanılmaktadır.
Ürün elektrostatik polyester toz boya ile tüm RAL renklerinde boyanabilir.
Kullanılan tüm vida ve aksesuarlar paslanmaz çeliktir.

Tempered glass
Aluminium profile
Water and dust proof with long-lasting silicon seals.
All nuts and bolts are stainless steel.
Electrostativ powder coated. All RAL codes could be applied.

CODE : **70.5365**

Teknik Çizim / Technical drawing

LED

45W / 6435 lm.

2700K, 3000K, 4000K, 6500K

   IP65

Ral 9005

Ral 9006

Ral 9016

• Tüm RAL seçenekleri / All colors available

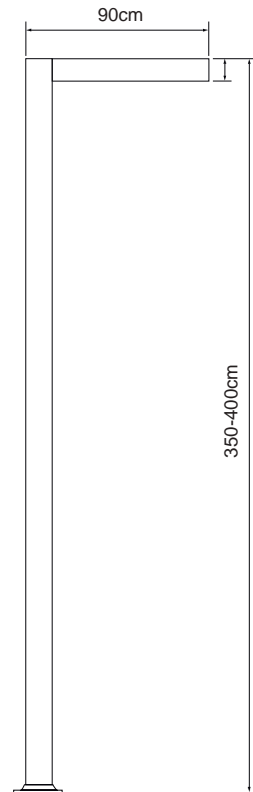



Isıya dayanıklı Temperli cam
Alüminyum profil
Uzun ömürlü silikon contalar kullanılmaktadır.
Ürün elektrostatik polyster toz boya ile tüm RAL renklerinde boyanabilir.
Kullanılan tüm vida ve aksesuarlar paslanmaz çeliktir.

Tempered glass
Aluminium profile
Water and dust proof with long-lasting silicon seals.
All nuts and bolts are stainless steel.
Electrostativ powder coated. All RAL codes could be applied.

CODE : **70.5375**

Teknik Çizim / Technical drawing

SMD LED

15W / 1800 lm.

2700K, 3000K, 4000K, 6500K

   IP65

Ral 9005

Ral 9006

Ral 9016

• Tüm RAL seçenekleri / All colors available

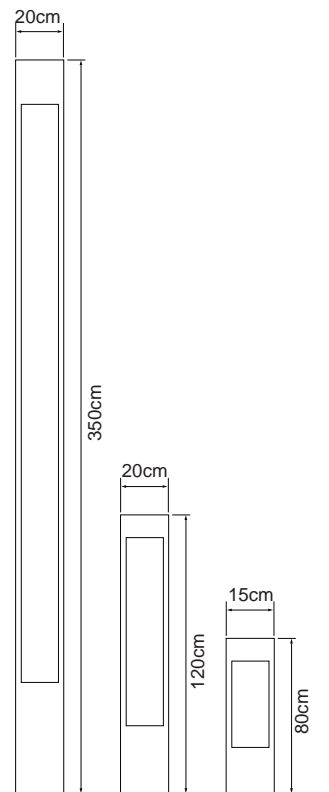



Galvaniz kaplamalı 2.5-3mm çelik boru.
Işıklık kısmı simetrik akrilik lens
Alüminyum led soğutma gövdesi.
Uzun ömürlü silikon contalar kullanılmaktadır.
Tüm dış vida ve aksamları civatalar paslanmaz çeliktir.

Galvanized coated 2.5-3mm steel pipe.
Skylight part symmetrical acrylic lens
Aluminum led cooling body.
Long lasting silicone gaskets are used.
All external screws and bolts are made of stainless steel.

CODE : **70.5380**

LED

2x52W / 2x7436 lm.

2700K, 3000K, 4000K, 6500K

□ CE V IP65

Ral 9005

Ral 9006

Ral 9016

• Tüm RAL seçenekleri / All colors available

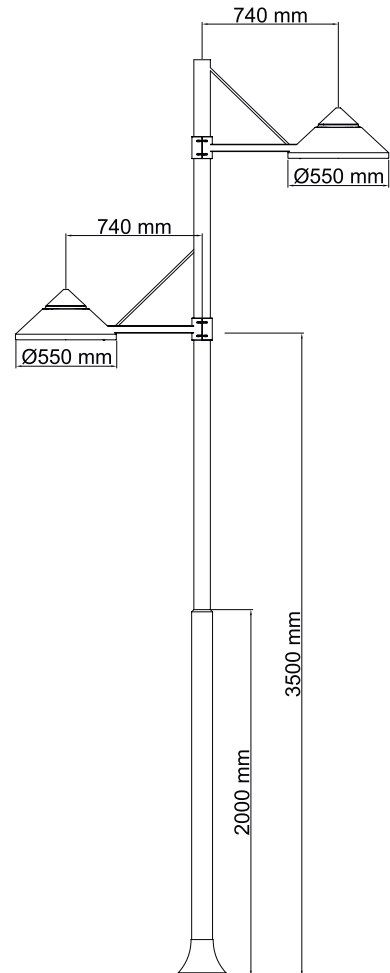

Galvaniz kaplamalı 2.5-3mm çelik boru.
Işıklık kısmı simetrik akrilik lens
Alüminyum led soğutma gövdesi.
Uzun ömürlü silikon contalar kullanılmaktadır.
Tüm dış vida ve aksamları çivatalar paslanmaz çeliktir.

Galvanized coated 2.5-3mm steel pipe.
Skylight part symmetrical acrylic lens
Aluminum led cooling body.
Long lasting silicone gaskets are used.
All external screws and bolts are made of stainless steel.

CODE : **70.5381**

LED

52W / 7436 lm.

2700K, 3000K, 4000K, 6500K

   IP65

Ral 9005

Ral 9006

Ral 9016

• Tüm RAL seçenekleri / All colors available

